

*J.E. Krepps, Jr.*

# electronics

radio, communication, industrial applications of electron tubes . . . engineering and manufacture



**JULY • 1941**

**PRICE 50 CENTS**

**McGRAW-HILL PUBLISHING CO., INC.**



# 5000 NEW DESIGNS



It is surprising to most people to find out that by far the bulk of U.T.C. production is on special units not normally catalogued. It is impossible to describe all these thousands of special designs as they become available.

The solutions to three typical customers' problems are shown below.

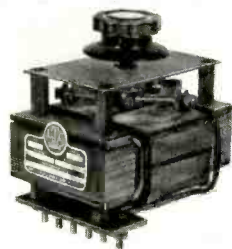

## FULL WAVE VARITRAN

● In one full wave rectifier application, our customer was employing a standard varitran with a step-down transformer having a center tapped secondary. The U.T.C. design division simplified this construction by developing a special varitran unit with an insulated secondary and a double contact structure, permitting a continuous variable voltage to be obtained each side of center. The step-down transformer is now entirely eliminated.

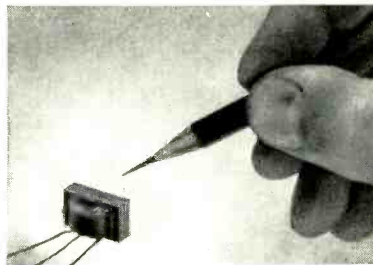

## THE SMALLEST

● In one special application the requirements call for the smallest output transformer possible, size and weight being of paramount importance. The design developed by U.T.C. has dimensions only 7/16" square by 3/4" high. Almost ten thousand turns are employed in the coil of this unit. Ten of these transformers weigh only three ounces.



## 600 AMP. VARITRAN

● In bending some types of tubing, it is desirable to heat the tubing to a highly ductile point, thus preventing kinking. A special U.T.C. varitran was developed for this application. This unit combines a standard varitran with a step-down transformer. The output current, for any type of load normally encountered, can be varied continuously from zero to 600 Amps. with direct meter calibration.

## MAY WE ASSIST YOU IN YOUR PROBLEMS?

The design ingenuity used in these applications has helped many users in other problems. The cumulative experience acquired in such development makes U.T.C. an ideal source for transformers to specifications.

# UNITED TRANSFORMER CORP.

150 VARICK STREET ★ NEW YORK, N. Y.  
EXPORT DIVISION: 100 VARICK STREET NEW YORK, N. Y. CABLES: "ARLAB"



# electronics

## CONTENTS—JULY, 1941

**KEITH HENNEY**  
Editor

Donald G. Fink  
Managing Editor (on leave)

Beverly Dudley                      Craig Walsh  
Acting                                      Associate Editor  
Managing Editor

M. L. Matthey                      J. M. Heron  
Assistant Editor                      Assistant Editor

Edward Grazda                      Harry Phillips  
Assistant Editor                      Art Director

**H. W. MATEER**  
Manager

Wallace B. Blood  
Sales Manager

Contents Copyright, 1941, by  
McGraw-Hill Publishing Company, Inc.

McGRAW-HILL  
PUBLISHING COMPANY, INC.

JAMES H. MCGRAW  
Founder and Honorary Chairman

Publication Office  
99-129 North Broadway, Albany, N. Y.,  
U. S. A.

Editorial and Executive Offices  
330 West 42nd St., New York, N. Y., U.S.A.

James H. McGraw, Jr., President  
Howard Ehrlich, Executive Vice President

Mason Britton, Vice Chairman  
B. R. Putnam, Treasurer  
D. C. McGraw, Secretary  
J. E. Blackburn, Jr., Director of Circulation

Cable Address:  
MCGRAWHILL, New York  
Member A. B. P. Member A. B. C.

### DUMONT TELEVISION READY FOR COMMERCIAL OPERATION . . . . . Cover

With commercialization of television at hand, DuMont's new equipment including electronic view finder (see page 58) has been completed

### EUGENE PHILLIPS, CONTRIBUTOR TO NATIONAL DEFENSE . . . . . Frontispiece

For method of improving technique of blind landing, Mr. Phillips won first place in Revere Copper and Brass Co. Award

### PRIORITIES AND THE ENGINEER . . . . . 15

Discussion of effects of priorities by radio engineers in Detroit brings out necessity of obtaining greater efficiency with substitute materials

### FIVE YEARS OF INDUSTRIAL ELECTRONICS, by Ralph A. Powers . . . . . 17

Summarized are the lessons learned by manufacturing electronics equipment for industrial purposes during the past five years

### REPORT OF THE INSTITUTE OF RADIO ENGINEERS . . . . . 21

Simplification of methods and labor saving devices for engineers afford theme for several technical papers, all of which are summarized by *Electronics'* staff

### VARIABLE EQUALIZER AMPLIFIER, by Henry A. Rahmel . . . . . 26

Amplifier with control of high and low frequency response is convenient, flexible unit adaptable to all commercial transcriptions

### INTERNATIONAL SHORT WAVE FACILITIES OF CBS, by A. B. Chamberlain . . . . . 30

Extensive facilities are being built by CBS to provide short-wave programs to South America and Europe. High points in development of complete communication system are outlined

### HYPEX HORNS, by Vincent Salmon . . . . . 34

Exceeding the exponential taper in low frequency response, new family of Hypex horns are suitable to many applications with improved results

### F-M MEASUREMENTS, by H. P. Thomas . . . . . 36

Second and final installment of an article outlining methods of measuring performance of f-m transmitters and of making determinations of field strength

### THE EARS OF THE ARMY . . . . . 40

Soldiers at Scott Field, Illinois, undergo intensive training in radio communication to equip themselves for problems of national defense

### BANDWIDTH FACTORS FOR CASCADE TUNED CIRCUITS, by C. E. Dean . . . . . 41

Rapid graphical and tabular method of determining the bandwidth for single and paired cascade tuned circuits

## DEPARTMENTS

CROSSTALK . . . . .	13	TUBES . . . . .	62
REFERENCE SHEET . . . . .	41	THE ELECTRON ART . . . . .	72
TUBES AT WORK . . . . .	46	BACKTALK . . . . .	79
NEW BOOKS . . . . .	50	INDUSTRY IN REVIEW . . . . .	81

INDEX TO ADVERTISERS . . . . . 90

ELECTRONICS, July, 1941. Vol. 14, No. 7. Published monthly, price 50c a copy. Allow at least ten days for change of address. All communications about subscriptions should be addressed to the Director of Circulation, 330 West 42nd Street, New York, N. Y.  
Subscription rates—United States and possessions, Mexico, Central and South American countries, \$5.00 a year, \$8.00 for two years, \$10.00 for three years. Canada (Canadian funds accepted), \$5.50 a year, \$9.00 for two years, \$11.00 for three years. Great Britain and British Possessions 36 shillings for one year, 72 shillings for three years. All other countries \$6.00 for one year, \$12.00 for three years. Entered as Second Class matter, August 29, 1936, at Post Office, Albany, New York, under the Act of March 3, 1879. BRANCH OFFICES: 520 North Michigan Avenue, Chicago; 68 Post Street, San Francisco; Aldwych House, Aldwych, London, W.C. 2; Washington; Philadelphia; Cleveland; Detroit; St. Louis; Boston; Atlanta, Ga.



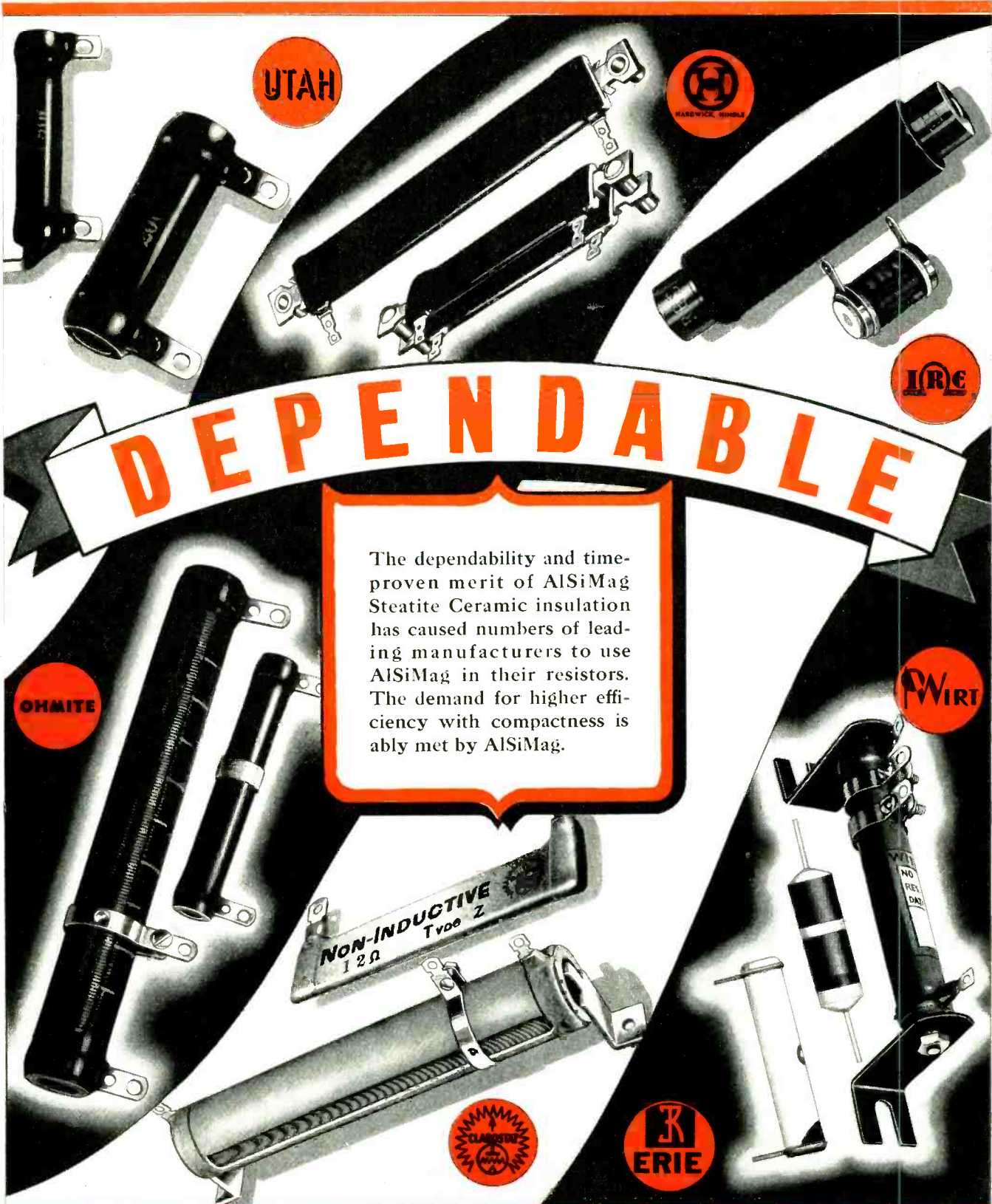

UTAH

HARRICK, MINNOLA

IRE

OHMITE

PWIRT

The dependability and time-proven merit of ALSiMag Steatite Ceramic insulation has caused numbers of leading manufacturers to use ALSiMag in their resistors. The demand for higher efficiency with compactness is ably met by ALSiMag.

NON-INDUCTIVE  
12Ω  
Type Z

CLARISTONE

K ERIE

ALSiMAG

Trade Mark Reg. U.S. Pat. Off.

FROM CERAMIC HEADQUARTERS

AMERICAN LAVA CORPORATION • CHATTANOOGA • TENNESSEE  
CHICAGO • CLEVELAND • NEW YORK • ST. LOUIS • LOS ANGELES • SAN FRANCISCO • BOSTON • PHILADELPHIA • WASHINGTON, D. C.



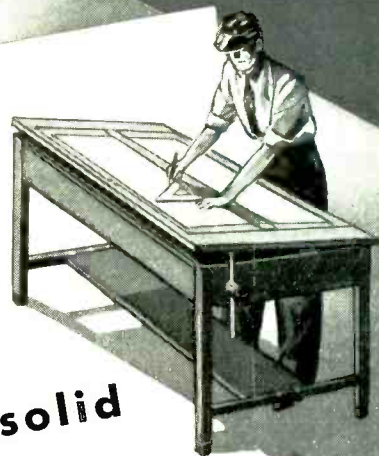
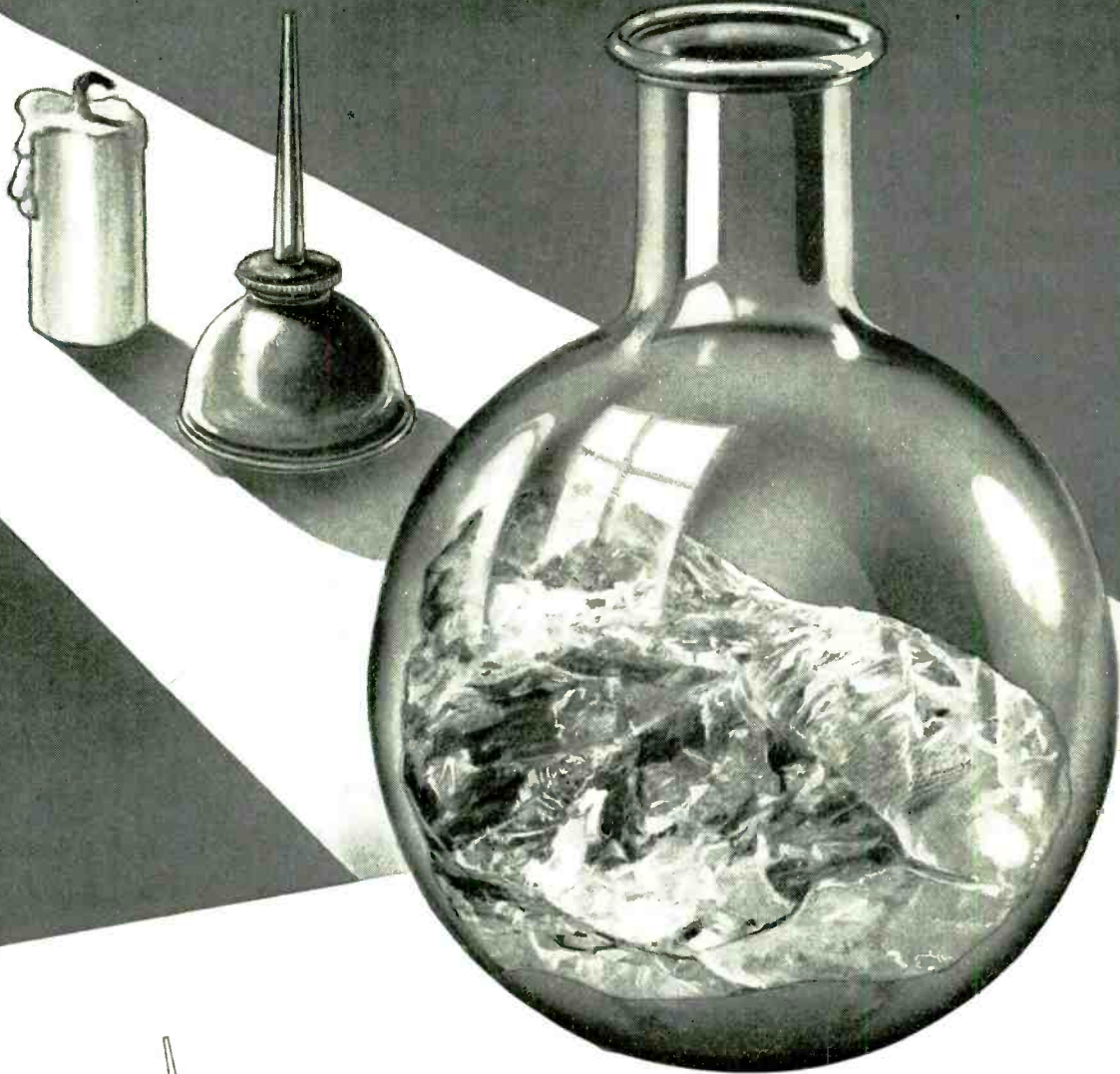



## A crystal-clear synthetic solid age-proofs this tracing paper



**MINERAL OIL.** Most tracing papers are treated with some kind of oil. Mineral oil is physically unstable, tends to "drift", never dries completely. Papers treated with mineral oil pick up dust, lose transparency with age.



**VEGETABLE OIL,** chemically unstable, oxidizes easily. Papers treated with vegetable oil become rancid and brittle, turn yellow and opaque with age.



**ALBANITE** is a crystal-clear synthetic solid, free from oil and wax, physically and chemically inert. Because of this new stabilized transparentizing agent Albanene is unaffected by harsh climates—will not oxidize with age, become brittle or lose transparency.



No oil, no wax—but a remarkable new transparentizing agent developed in the K&E laboratories—produces this truly permanent tracing paper! **ALBANENE** is made of 100% long fiber pure white rags—treated with **ALBANITE**—a new crystal-clear synthetic solid, physically and chemically inert. **ALBANENE** will not oxidize, become brittle or lose transparency with age.

Equally important, **ALBANENE** has a fine hard "tooth" that takes ink or pencil beautifully and erases with ease... a high degree of transparency that

makes tracing simple, produces strong sharp blueprints... extra strength to stand up under constant corrections, filing and rough handling. **ALBANENE** has *all* the working qualities you've always wanted—and *it will retain all these characteristics indefinitely.*

Try **ALBANENE** yourself on your own drawing board. Ask your K&E dealer, or write us, for an illustrated brochure and a generous working sample.

EST. 1887  
**KEUFFEL & ESSER CO.**  
NEW YORK—HOBOKEN, N. J.  
CHICAGO—ST. LOUIS  
SAN FRANCISCO—LOS ANGELES—DETROIT—MONTREAL

**K&E Albanene**  
REG. U. S. PAT. OFF.  
**THE STABILIZED TRACING PAPER**



# PRECISION TESTING EQUIPMENT..

*an important factor in the high quality of*

*Erie Components*

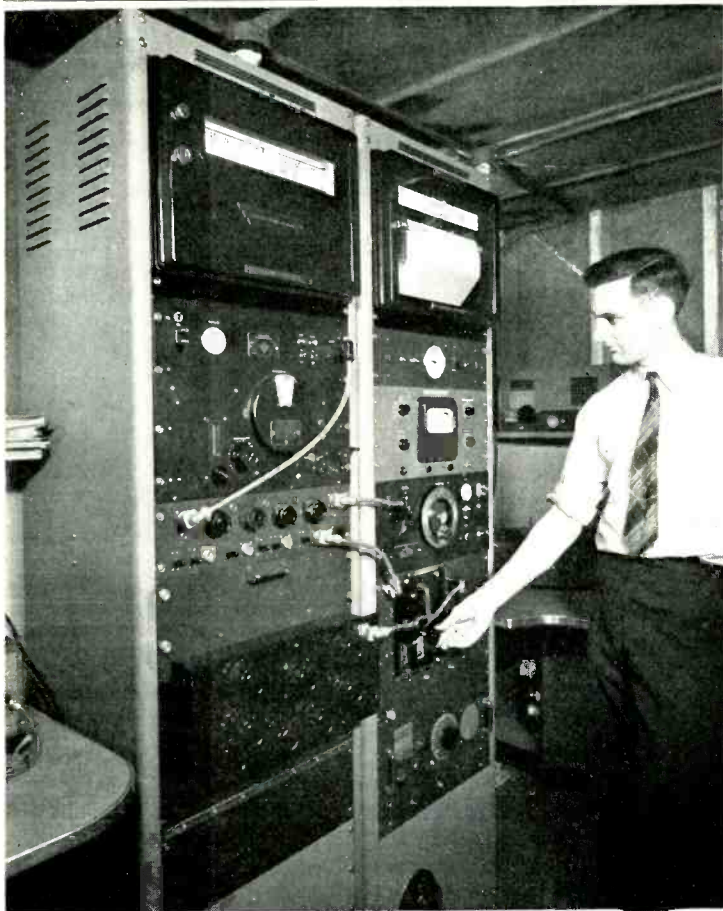

To insure the maintenance of the high quality of Erie radio components, our research and development department has extremely complete facilities for testing resistors, suppressors and condensers for almost every conceivable characteristic. Pictured at the left is a specially designed oscillator for checking the temperature characteristics of Erie Ceramicons. A detailed description and functional diagram of this equipment is given below.

You can depend on Erie Radio Components in your equipment. Their performance is based on engineering facts, not guesswork.

The Equipment illustrated is used to obtain a continuous record of capacity change as temperature is automatically raised at the rate of 2° per minute from -40° to +100° C.

Condenser under test is placed in an electro-statically shielded, convection heated oven, a program control raising temperature at a known uniform rate. Condenser forms part of resonant circuit of a very stable Oscillator, thus controlling its frequency to a known degree. Operating frequency may be set at any frequency from 500 K.C. to over 60 M.C. Output of oscillator is fed to input of stable Heterodyne Frequency Meter. The beat frequency output of this instrument is fed to an Electronic Audio Frequency Meter for visual indication of frequency change, and Recording Microammeter makes a permanent record of frequency change.

A calibration of capacity change in terms of frequency change can of course be easily made. Also, since temperature change is uniform with respect to time, time scale on frequency change chart can be calibrated in terms of temperature, so that final scales on chart are simply capacity change against temperature.

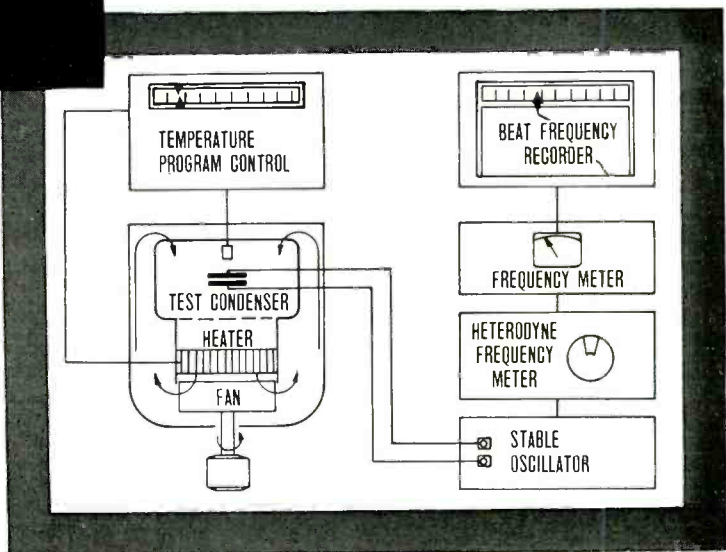

**ERIE RESISTOR CORP., ERIE, PA.** LONDON, ENGLAND · TORONTO, CANADA.





1. **COPPER TO GLASS** sealed thimble connector. Provides low resistance and operates at least 50° Centigrade cooler than ordinary tungsten seals. Glass cracks are eliminated.
2. **RUGGED PLATE SUPPORT.** Low lead inductance for UHF operation.
3. **PLATE CAP CONFINES** electron stream at UHF. Protects glass from high velocity electrons and increases tube efficiency.
4. **FULL TANTALUM PLATE** and grid cleaned, processed, pumped by new improved GAMMATRON methods.
5. **RUGGED GRID CONNECTOR,** copper to glass seal, low inductance grid lead — neutralization is easy.
6. **IMPROVED GAMMATRON FILAMENT,** ample emission, long life, and mechanically rugged.
7. **FILAMENT STEM SHIELDED** from high velocity electrons. Will not fail.

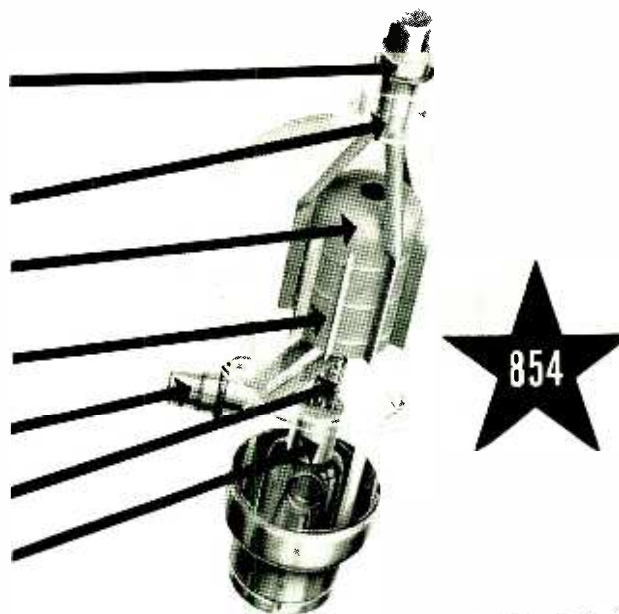

# 3 NEW GAMMATRONS

Three new GAMMATRON tubes designed to meet your exacting requirements, with these features: Exceptional UHF efficiencies, ability to stand high plate voltage, complete protection against failure through overloads, and extra long life.



Years-ahead performance			
TUBE TYPE	454	854	1054
MAX. OUTPUT	900	1800	3000
PLATE DISS.	250	450	750
AMP. FACTOR	14 — 30	14 — 30	13
MAX. FREQ. MC.	150	125	100
FIL. VOLTS	5.0	7.5	7.5
FIL. AMPS.	11	12	21
NET PRICE	\$27.50	\$75.00	\$175.00

WRITE FOR FULL DATA

HEINTZ AND KAUFMAN  
SOUTH SAN FRANCISCO, CALIF. U.S.A.

## GAMMATRONS OF COURSE



# The CENTRALAB Family

## of VOLUME CONTROLS

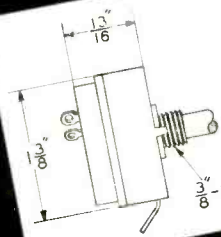

### STANDARD

Long famous for the reliability of Centralab's non-rubbing contact and long wall type resistor. Available plain, or with one, two, or three taps, and with SPST, DPST, or SPDT Underwriters Approved switches.

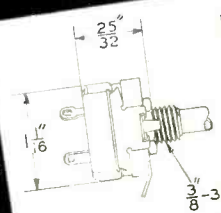

### MIDGET

Small in size, but large control efficiency due to the long straight path of the wall type resistor. Fits well in crowded chassis as solder lugs do not project far beyond the control radius of 17/32". Available single, dual, or triple, plain, or tapped, with SPST, SPDT, DPST, and a special dial lite push switch for battery sets.

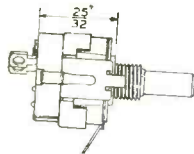

### ELF RADIOHM

Small . . . but it too, features the long, straight, resistor strip . . . a particular advantage in producing good curve characteristics and low noise level . . . with S.P.S.T. Switch . . . with or without dummy lug. Switch rated . . . 2 Amps. 125 V. Underwriters approved.

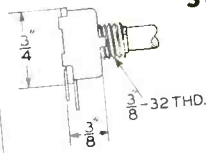

### SUB-MIDGET

The smallest diameter reliable control. Long wall type resistor gives low noise level. Rapid Transfer of heat from resistor to metal shell gives maximum load rating of 1 1/2 watts. No switch or taps. Available as grounded or insulated rheostat or potentiometer with solid or tubular shaft.

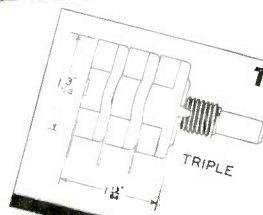

### TWIN AND TRIPLE CONTROLS

Two or three sections assembled in tandem for special purposes. Each section fully shielded and has independent connections. All variable controls attached to a single shaft. Twin one inside the other. Supplied with or without Underwriters Approval snap switch.

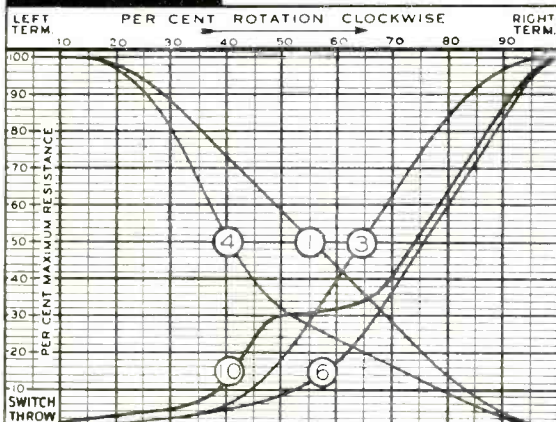

The resistor curve of a volume control is more important than its overall resistance . . . that is why Centralab controls are furnished with the variety of curves shown here. Curve six is most widely used for high resistance radio grid and diode controls. Curve 1, or 4, are best for C bias, and Curve 3 for antenna C bias. Curve 10 is used on tapped controls.

# Centralab

CENTRALAB • 900 E. KEEFE AVE • MILWAUKEE, WISCONSIN  
A Division of GLOBE-UNION INC. Cable Address: Centralab Milwaukee



# Check Before You Choose

## SIMPLICITY plus Unexcelled Performance

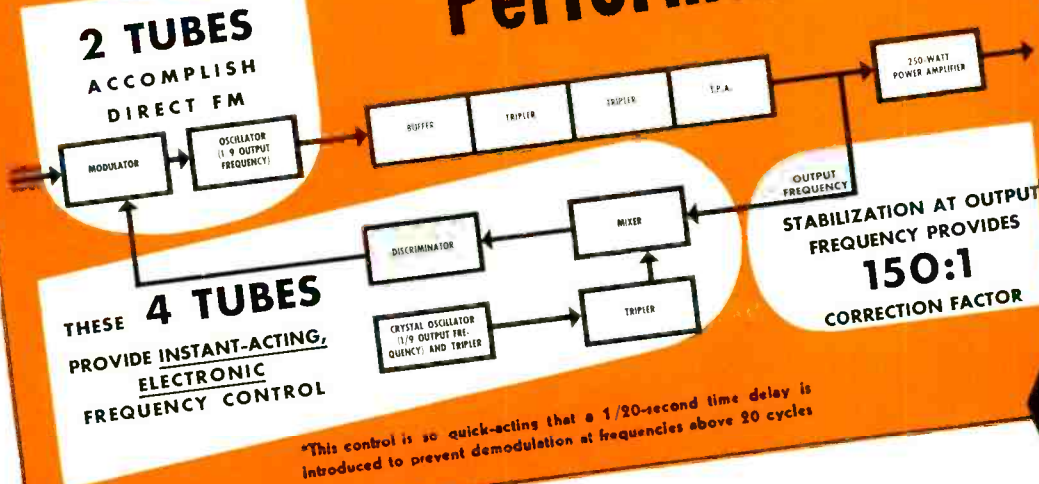

And you'll specify



SIMPLIFIED

**FM**

CIRCUIT DESIGN

### INSIST ON ALL THESE . . .

#### Continuity of Service

- Automatic reclosing overload protection
- Instant access to every tube (no shielding to remove)
- Complete accessibility without disassembly
- Only 2 tubes to produce *direct* FM
- Only 4 tubes in stabilizing circuit
- Single crystal control

#### Frequency Control

- Instant-acting electronic (no moving parts; no overshoot)
- Stabilization at *output* frequency
- Temperature control of crystal only
- $\pm 1000$  cycles stability
- Voltage regulated power supply
- New G-31 crystal unit
- Temperature *compensated* oscillator and discriminator circuits

#### High Fidelity

- Frequency response within  $\pm 1$  db of RMA standard, 30 to 16000 cycles
- Full dynamic range—noise level down 70 db
- Linearity within 0.25% up to  $\pm 150$  kc carrier swing
- Harmonic distortion less than 1½% (30 to 7500 cycles) up to  $\pm 75$  kc carrier swing; less than 2% up to  $\pm 100$  kc swing
- Cathode-ray modulation indicator
- Square-wave testing of every transmitter

#### Economy

- Based on G-E 1000-watt Transmitter, Type GF-101-B
- Tube cost—only \$287
- Floor space—only 9.3 square feet
- Ventilation—natural draft (no blower; quiet operation)
- Power consumption only 3.75 kw

**F**OR CONTINUITY OF SERVICE, G-E design provides a small tube complement, conservatively operated, plus automatic reclosing overload protection and quick accessibility to every part and tube.

The frequency stability of G-E transmitters is maintained at within  $\pm 1000$  cycles by *instant-acting* electronic control so sensitive that even abnormal line-voltage fluctuations or *sudden detuning of the oscillator tank* can have no effect on center frequency.

The dependability is equal to that of the finest AM broadcast transmitters. *FM could ask no more.* G-E design centralizes frequency modulation and stabilization in one tube (the modulator), without impeding modulation capabilities or linearity. This fact is proved by performance measurements. No temperature control is necessary or used except within the crystal unit itself.

For true high fidelity—frequency response, linearity, freedom from distortion over wide carrier excursions—G-E transmitters are outstanding. These characteristics—inherent in the G-E simplified circuit—are assured by thorough factory adjustment and testing of every unit.

For economy, G-E simplicity assures low tube cost, ease of maintenance, and small operating expense. Small size and unit construction make installation easy and hold floor space to the minimum.

*G-E simplified circuit design offers an unbeatable combination of advantages. Investigate them thoroughly. Your nearby G-E man has the story. Call him in without delay. General Electric, Schenectady, N. Y.*

GENERAL  ELECTRIC



MANAGER



ENGINEER



OPERATOR

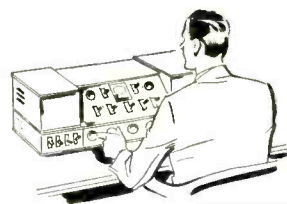

## FROM EVERY POINT OF VIEW ... it's a Natural!

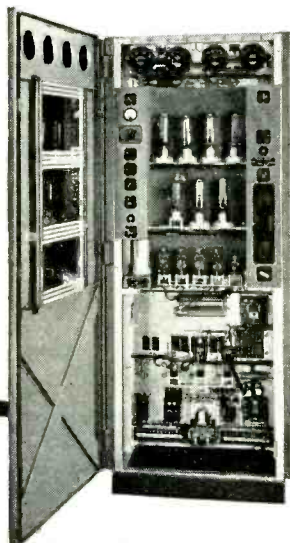

Open the front door—all apparatus in the front section, including vacuum tubes, is completely accessible.

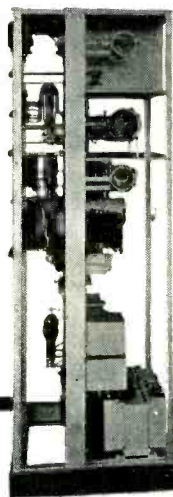

All electrical components, except door switches, are mounted on the central structure.



Go around to the back door and you get still further evidence of high quality workmanship and accessibility.

## Ask your Engineer about this new 250 Watt Transmitter

KGBS —Harlingen, Texas  
 KHMO—Hannibal, Mo.  
 KMYR—Denver, Colo.  
 KPHO—Phoenix, Ariz.  
 KSWO—Lawton, Okla.  
 WAIM—Anderson, S. C.  
 WEBQ—Harrisburg, Ill.  
 WERC—Erie, Pa.  
 WINC—Winchester, Va.  
 WITH—Baltimore, Md.  
 WJMA—Covington, Va.  
 WMRF—Lewistown, Pa.  
 WSLs—Roanoke, Va.  
 WWDC—Washington, D. C.  
 Southwest Broadcasting Co.  
 —Pulaski, Va.

You can see for yourself that Western Electric's new 451A-1 is compact, accessible, stylish. It's outstanding in performance, too—engineered by Bell Labs for highest signal quality, low power consumption, low tube cost, low maintenance cost.

Features your engineer will like: frequency response flat within 1.5 db from 30 to 10,000 c.p.s.—r.m.s. noise level 60 db or better unweighted, 70 db weighted below signal level at 100% single frequency modulation—Grid Bias Modulation of last RF stage.

Those are just some of the reasons why the 451A-1 has been chosen by the stations listed. For details, ask Graybar for Bulletin T-1752.



# Western Electric

Ask your Engineer!



**DISTRIBUTORS:**  
 In U. S. A.: Graybar Electric Co., New York, N. Y. In Canada and Newfoundland: Northern Electric Co., Ltd. In other countries: International Standard Electric Corp.



**THIS CURVE  
DOUBLES  
THE STRENGTH  
OF ANTENNA  
STRUCTURE  
INSULATORS**



This is the Lapp compression cone of electrical porcelain, a design conceived by Lapp engineers as being most suitable for carrying the mechanical and electrical loads imposed on insulators for antenna structure support. For 20 years every Lapp footing and guy insulator has been built around the porcelain compression cone. The *curved-side* cone, developed as towers went higher and loads heavier, is *twice* as strong as the earlier, straight-side cone. No antenna structure has ever failed because of the failure of a Lapp porcelain part. Lapp Insulator Co., Inc., LeRoy, N. Y.

*Specify*

**LAPP**

**FOR SECURITY IN ANTENNA STRUCTURE INSULATORS**



**. . . . IN ALL RATINGS;  
FOR ALL REQUIREMENTS**

# *Transformers for Electronic Circuits*

Type RS plate transformers and reactors, oil-immersed type, for large rectifiers.



**Continuous Research work by our engineers since the early days of radio**

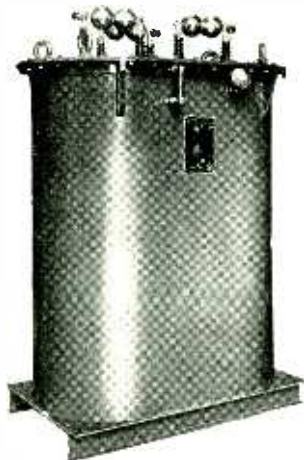

has made and maintained the AmerTran trademark a symbol representing the ultimate in transformers for communication and electronic circuits. This also explains why our products are preferred and used by so many of the largest equipment manufacturers and best-equipped broadcasting stations. Today our list of products covers the complete range of transformer requirements for electronic tube circuits—from the smallest audio unit used in an air-craft radio receiver to the giant power and modulation transformers for a 50,000 watt broadcast transmitter. Furthermore, all types and sizes can be produced economically either singly or in quantity to meet your particular specifications.



AmerTran modulation transformer, oil-immersed type, for large broadcast transmitters.

AmerTran audio transformers and reactors are available for all applications and meet exact requirements.

Type W plate transformers and reactors for all small and medium high-voltage rectifiers.



Type W filament transformer, air-insulated type, for tests up to 50 Kv.



• *Let us submit data on transformers for your requirements.*



**AMERICAN TRANSFORMER COMPANY**

178 Emmet St.

Manufacturers  
SINCE 1901  
at Newark, N. J.

NEWARK, N. J.

# AMERTRAN



# “Consider a Capacitor’s Dependability”

## THERE’S EXTRA DEPENDABILITY IN LONGER LASTING C-D CAPACITORS

Sound advice to engineers and purchasing agents is the capacitor recommendation of Canadian Colonial Airways. Consider dependability. You get *extra* dependability when you specify Cornell-Dubilier capacitors, because the broadest experience in the industry is behind them — more than 31 years of specialization in capacitor manufacturing.

Cornell-Dubilier superiority is hidden to the eye. But it’s there in the capacitor ingredients . . . in the quality of parts, in the skillfulness of fabrication — and it shows in service. So much so that Cornell-Dubilier capacitors are the unanimous choice today of America’s leading airlines for all aircraft and ground transmitting and receiving communications equipment. Whatever your capacitor requirements, it pays to specify C-Ds.

**CANADIAN COLONIAL AIRWAYS Inc.**  
COMMUNICATIONS DEPT.  
EQUIPMENT CHART

PART	50515859806125CPS
BEACON RECEIVER	27105397
AUXILIARY RECEIVER	1009 1003 176
COMPARISON UNIT	439 186 86
MICROPHONES	
HEADSETS	
AUXILIARY BATTERY	
LOOP	
LOOP AMPLIFIER	
LOOP DRIVER	
AZIMUT	

MICA • DYKANOL • PAPER • WET & DRY ELECTROLYTIC CAPACITORS



## CAPACITORS MAY LOOK ALIKE BUT . . .

*There is extra long life, extra uniformity and dependability built into C-Ds. Next time you specify capacitors look for the Cornell-Dubilier seal of experienced engineering. And get the hidden extras at no extra cost. Send for Catalog, Cornell-Dubilier Electric Corporation, 1006 Hamilton Blvd., South Plainfield, New Jersey.*

# Cornell Dubilier

SOUTH PLAINFIELD, N. J.

NEW BEDFORD, MASS.



. . . MORE IN USE TODAY THAN ANY OTHER MAKE . . .



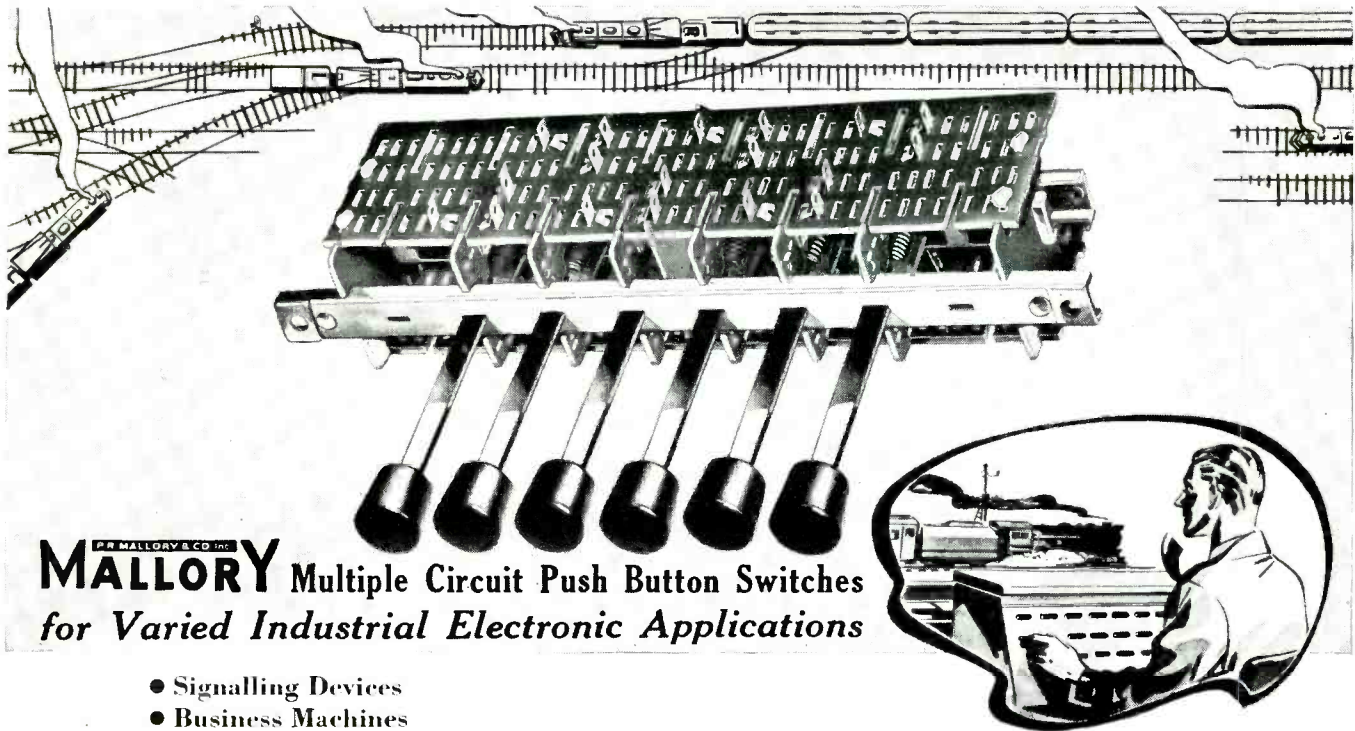

**P. R. MALLORY & CO. INC.**  
**MALLORY** Multiple Circuit Push Button Switches  
 for Varied Industrial Electronic Applications

- Signalling Devices
- Business Machines
- Electrical Tabulating Equipment
- Machinery Control
- Intercommunication Systems
- Public Address Amplifiers
- Program Distributing Systems
- Microphone and Input Switching, and Equalizer Network Switching in Broadcast or Telephone Equipment
- Tube Testers and Servicing Instruments

Many applications on which it is necessary to close several circuits and automatically open any previously closed circuits are made easier and more efficient through the use of Mallory Multiple Push Button Switches.

They are available in standard types such as No. 2196, illustrated above.

It may well be that Multiple Push Button Switches are furthest from your regular or even occasional needs. But there's this to remember . . . there is scarcely an industry that does not have use for one or more of the many Mallory approved precision products . . . as original equipment, in processing, in maintenance or in experimental development. Three distinct circuit combinations — circuit closing, circuit transfer, and non-shorting circuit transfer — are stocked for prompt shipment. Send for special folder No. Y-608B.

**P. R. MALLORY & CO., Inc., INDIANAPOLIS, INDIANA**

Cable Address — PELMALLO

*Send for this catalog*

Catalog #770-A will save time for both your engineering and purchasing departments. Be sure you have it on file.

Made under United States Letters Patents 2,231,103; 2,146,269 et al.





# CROSS TALK

► **STAFF . . .** On May 15, Don Fink left the desk he has occupied as Managing Editor of *ELECTRONICS* since June 1937. Mr. Fink has been granted a leave of absence from his duties with *ELECTRONICS* which he took up on June 1 seven years ago, in order to work on a radio defense project. Fortunately, he will have a certain amount of time to devote to *ELECTRONICS*. A considerable portion of the report in this issue on the I.R.E. Detroit convention was prepared by him while attending this meeting.

Seven years is a long time. In that period Don Fink's acquaintances in the industry have grown until there is scarcely a communications engineer who does not know him personally. His ability to quickly grasp the significance of a highly technical paper and to write a lucid and thorough description of it, long after hearing it delivered, has contributed much to the up-to-dateness of *ELECTRONICS*' editorial pages, and in one instance at least has been criticized by one of the engineering societies for stealing the thunder of the society publication. His continued interest in the new things of radio such as television, fm and uhf, has lead directly to our loan of him to the defense project.

Lest this note take on the effect of an obituary, let us hasten to state that the arrangement is temporary and that while the pages of *ELECTRONICS* will miss the effectiveness of his typewriter, they will not be deprived of his work permanently.

During Don Fink's absence from active duty with us, Beverly Dudley will be relieved of some of his duties as managing editor of *Photo Technique* to carry on as Acting Managing Editor of *ELECTRONICS*. "Dud" came to the staff from RCA Radiotron in September,

1936, shifting full time to *Photo Technique* when the latter was born. After two years at Armour Institute in Chicago, he spent a year with the A.R.R.L. in Hartford, then becoming Assistant Secretary of the I.R.E. leaving in 1932 for M.I.T. where he took his degree in 1935. Summers during this period he worked for General Radio and seems to have done all kinds of other work at night and during vacations. Maintenance of repeaters for A.T.&T., writing columns for the *Chicago Evening Post*, graduate study in electrical engineering at Columbia University, arguing with KH about photographic problems—which finally landed him on *Photo Technique*. At the moment there seems to be some doubt in Dud's mind whether he is a photographic or an electronic engineer, but our guess is that he is an engineer-editor and that both of our papers will continue to benefit by his interests and experience.

Two years ago the staff was augmented by the presence of Craig Walsh, a Stevens Tech M.E. of 1934. At Arc-turus Radio Tube Co., he was listed on the payroll as engineer (without title), learned about tubes and their innards, worked on both development and production problems, leaving for Carrier Corp., where he tried to forget radio by selling air conditioners. Found it didn't work and then spent some time at National Union Radio Corp., where he tried to keep  $g_m$  under control (a production problem) and built a television signal generator under M. G. Nicholson. Now feels he can build anything. He continues to serve as Associate Editor; now with the assistance of Edward Grazda, a junior from New York University who will help the staff over the summer vacation period.

Aside from two fair members of the

staff who help tremendously in keeping a steady flow of editorial copy to the printer, who read proof, write letters, ward off importuning visitors, answer the telephones, and do the other thousand and one things that keep things moving, this completes the roll—except for the Chief Editor.

Fortunately the space available for this roll call is limited. The staff members who do the real work have been reported on. Suffice it to say therefore that KH became Chief Editor in 1935 when *ELECTRONICS* was at the crossroads, and when it seemed desirable to make something, financially, out of the paper. A bold step, initiated by Howard Ehrlich, now Executive Vice-president of the company, expanded the service offered by the editorial pages, raised the subscription price from \$3 to \$5 annually, and in spite of original misgivings, ultimately raised the circulation from approximately 6000 to its present net paid of 16,010. This would not have been possible without the continued aid of many unsung friends who have tipped us off to worthwhile articles, who have read manuscripts on which we needed guidance, who have taken us apart when we needed it.

A technical paper does not differ from other publications; its chief revenue comes from advertisers. But advertisers do not spend money in a paper for the fun of it, they want readers. And readers are attracted to a publication by its contents and the contents are written partially by editors and partly by people who never see the inside of an editorial office and who have not the remotest idea of the many trials and tribulations of being an editor, but who, nevertheless, contribute to a successful co-operative venture.

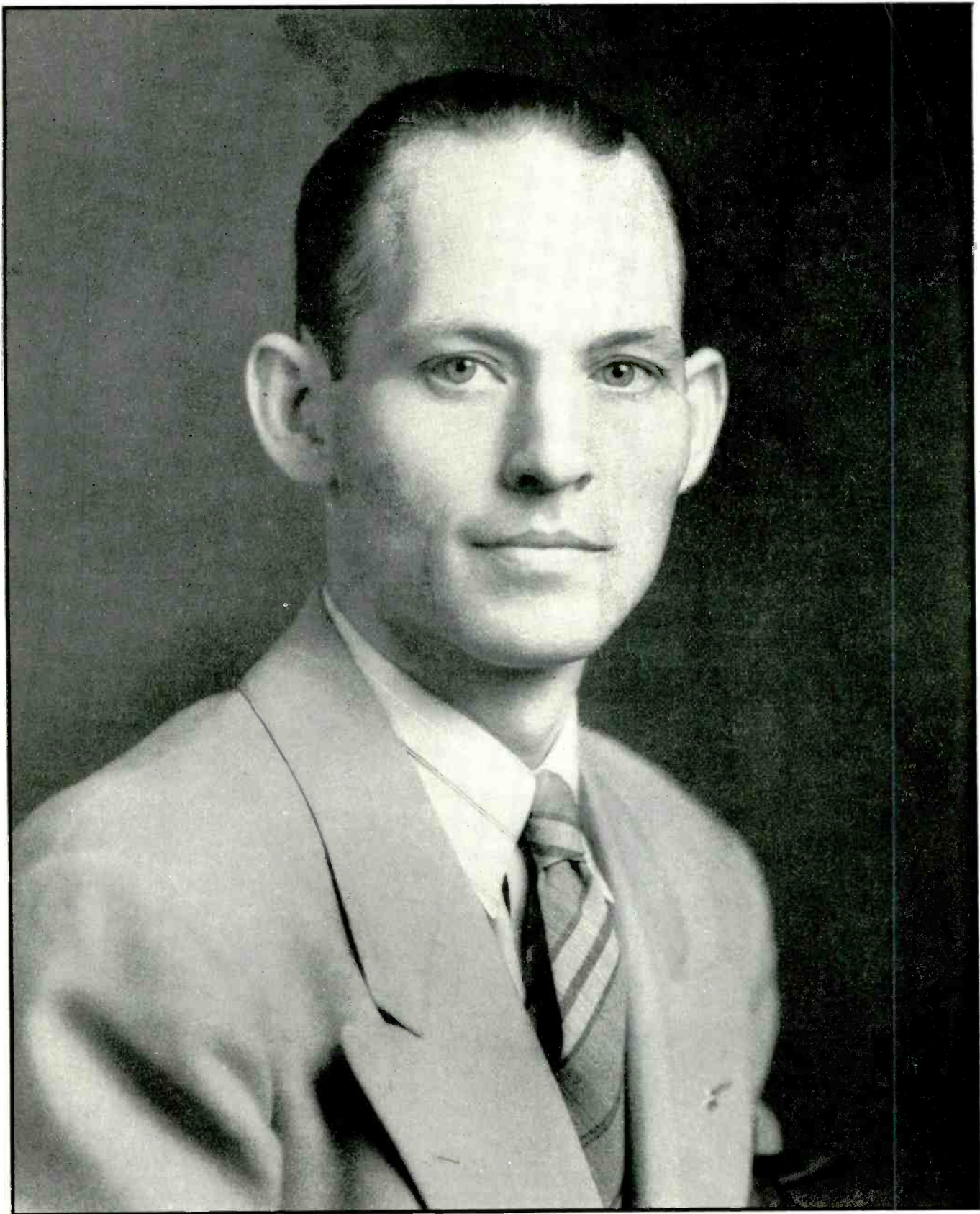

**EUGENE PHILLIPS** . . . . . of Fort Worth, Texas, winner of first prize of \$5000 in the Revere Copper and Brass Award for contributions made by workers in the metal-working industries to America's defense plans. Out of 2000 entries Mr. Phillips won first prize for his method of improving the technique of blind landing of airplanes. Distinctly a radio method, the scheme has attracted the keen interest of military and civil aircraft people and trial installations will be made soon of the plan on which the young technician had been working for seven years



# Priorities and the Engineer

---

Shortage of essential raw materials, shortage of certain manufacturing facilities, the necessity for the development and use of more efficient circuits and components made of substitute materials is foremost problem confronting electronics engineers

---

THE radio and electronics industry faces a most unusual and disconcerting production problem this Fall.\* There is every indication of a larger potential consumer market than has ever existed before; business should be good under normal conditions—excellent in fact. Sore spot in this story, however, is the fact that there is good prospect that many orders will remain unfilled through lack of materials, lack of production facilities, lack of adequate supply of labor, lack of development or discovery of suitable substitutes for essential raw materials which have gone into the defense program, or other deficiencies caused directly or indirectly by the present National Defense Program. Under the circumstances, the full potentialities of the market cannot possibly be taken advantage of.

Priorities of materials is the biggest stumbling block facing the industry for the next several months or more. To carry on for the next three to six months with even a faint resemblance to normalcy is going to require the combined aid of executives, engineers, research physicists and production managers.

Because of priorities assignments of materials to those projects closely identified with national defense, severe limitation or even complete disruption of civil radio communication is not a remote ephemeral dream; it is well within the pale of early realization unless steps are taken immediately to meet the conditions as they may be expected to exist in the near future. Hard headed, practical engineers, designers, and production managers are rapidly becoming aware of the impending crisis and face the prospect of many forced changes if they are to supply any

noteworthy amount of civilian radio equipment.

Nearly all of the raw materials going into the radio field are those required for important national defense activities—aluminum, chromium, nickel, steel, tin, zinc, ceramics, plastics, paper, and certain types of insulating materials to mention but a few. Without these materials, or satisfactory equivalent substitutes, the radio industry cannot exist except for the fulfillment of orders of military necessity. Any drastic curtailment of civilian radio communication might easily have serious and important consequences, for the dependence of the civil population upon radio communication systems may, of itself, be a factor of major political and military importance.

For the radio and electronics engineer, the future is not a path of roses, but neither is it entirely hopeless if the proper resolution and energy is directed toward a solution of the incipient headaches. Much can be done to circumvent future difficulties, but the necessary action requires the whole-hearted cooperation of all concerned—executives, engineers, research workers, production managers, and suppliers of raw and finished goods.

## *What Can Be Done?*

Once having faced the problem squarely and having recognized the existence and seriousness of the emergency, much can be done to ease the shock of the next few months production and design.

First of all, knowing what materials are more or less restricted for civilian radio production, engineers and research workers have a huge task carved out for them in designing equipment and circuits which make most efficient use of those materials which are relatively plentiful and in developing substitutes for

those materials which are restricted entirely or largely to purely military purposes. The opportunities for long lived and meritorious service—to say nothing of headaches—are great.

Secondly, and closely related to the utilization of substitute materials, is the problem of conserving existing available materials and the efficient utilization of available materials. Additional benefits are also obtainable through the fullest utilization of programs of standardization and simplification. Through standardization it is possible to reduce inventory stocks of different types and sizes, to effect certain flexibility through interchangeability of parts, and—strangely enough—to attain these advantages with little other sacrifice other than the decision to map out a program of definite and specific objectives, and then following through with this program. In some cases it may be necessary through force of emergency circumstances, to take a more tolerant view than heretofore on such matters as background noise, hum, and the like, but the ingenuity of engineers can be counted upon to overcome, quickly and effectively, any necessary temporary relaxations.

Another advantageous procedure which will help the industry is long term planning (so far as this is possible in the present emergency) and the ordering of essential raw materials in accordance with a rational estimate of their anticipated use. Bottlenecks can easily arise if all should suddenly request immediate delivery even on those items which could not possibly be used for months to come. These could be greatly alleviated by scheduling deliveries in accordance with their actual or truly anticipated requirements rather than in accordance with hoarding instincts. A careful, cautious check of inventories is an important step in this process.

\* The material presented in this article is essentially that discussed at an informal meeting at the Summer Convention of the Institute of Radio Engineers in Detroit, on June 25, 1941.

With not a few failing to appreciate the future consequences of the present emergency measures and with priorities ratings changing daily, it is impossible to make any hard and fast statements of the situation in any one field. Still, a summary of the present case, so far as it can be seen by some of those most intimately associated with production problems in the radio and allied fields, may be of interest and value as a guide to the solution of the problems of others.

**Plastics.** In the fabrication of plastics, such as phenolics, vinals, styrenes, and acralites, a lack of long term planning in the past is responsible, to a large extent, for the present sudden and heavy demands for products. There do not appear to be any serious difficulties, either present or anticipated, in obtaining the raw materials for the fabrication of plastics, although some difficulty may be experienced in fabrication because of labor disputes, lack of adequate production facilities, and similar matters. At present, the outlook appears to be as dark as it will ever be; the future looks more promising than the present. Prices of raw materials do not fluctuate greatly and in general, in the chemical industry, the trend of prices is downward. Increases in the price of raw materials which, so far, have not occurred to any appreciable extent, and taxes introduce a note of decided uncertainty.

**Batteries.** The future availability of dry cells and batteries is so intimately tied up with the availability of zinc that anything now seems possible. Zinc supply appears to be adequate to meet production demands for the next few months, although after that production may have to be curtailed since there appears to be no satisfactory substitute for zinc which is under mandatory control.

Reduction to a minimum of the various types and sizes of cells is one possible method of easing this situation. This is primarily a problem in commercial standardization. More efficient utilization of materials in battery production, and the employment of more efficient tubes and circuits in which batteries are used, with reduction of the number of battery models, are methods of relieving the strictly non-essential demands on zinc. It is not expected

that there will be any shortage of carbon, but depolarizing agents other than manganese dioxide may have to be employed.

**Condensers.** With aluminum entirely consigned to defense projects, electrolytic condensers for civilian radio needs will be conspicuous by their absence. Also, rubber and bakelite parts are expected to be difficult to obtain, and deliveries of electrolytic condensers are now considerably behind schedule. Condensers for delivery in October are available with zinc instead of aluminum shells. In general, the outlook for Fall deliveries is anything but encouraging.

To ease the demand for electrolytic condensers, it has been proposed that wherever possible, designers make use of dry electrolytic condensers having cardboard instead of metal shells, with bare instead of insulated terminal leads, and that standards be established for two sizes of condensers with not more than three sections in each size.

As for other fixed condensers, a better picture is possible but not too encouraging. No India mica is available for mica condensers and Brazilian mica is now being used. Canadian and New England sources of supply may provide the bulk of the mica in the future. Tin and aluminum are already under priorities control, but lead can be used in paper dielectric condensers. Now, however, another bottleneck appears; this time it is paper. Formerly, dielectric paper was imported, but shipping facilities and general conditions abroad have put a stop to this practice. A possible development is the use of plastic films as the dielectric and research has been in progress for some time on this problem, but to date no commercial developments have been announced. The shortage of paper may be of less practical importance than limitation of winding facilities, especially since power correction condensers used in fluorescent lighting units have introduced heavy load on the facilities for winding paper condensers. Cutting down on the number and size of fixed condensers for radio sets is distinctly advisable.

Greater possibilities for substitution appear possible with variable tuning condensers than with fixed condensers. The use of copper

plated light gauge steel for the stator plates is a possibility which looks attractive at the present time.

**Iron Core Inductors.** Because domestic production of carbonyl iron powders which are equal in quality to those formerly obtained from Europe (at least in the broadcast band) has increased of late, an adequate supply of powdered iron for inductors seems assured. Likewise, no shortage of bonding materials seems imminent. The principal bottleneck for this important component is the brass adjusting screws which may be limited either because of lack of raw material or because of lack of machine tools for making the screws. Use of adjusting screws of minimum size, with perhaps alteration in design to eliminate brass fittings completely, are promising methods of solution. Here, as in other cases already mentioned, origination and adherence to strict program of standardization would be highly beneficial.

**Steel.** Shortage of steel for the radio industry does not, apparently present a serious problem. Many specialty items using alloys with appreciable amounts of chromium and nickel may prove to be a stumbling block of considerable importance in spite of the fact that these metals are used in relatively small quantities. For example, the inability to obtain chrome and nickel steels may alter production methods on vacuum tubes where glass-to-metal seals are now common practice.

**Tubes.** No data is available directly from any of the large producers of tubes regarding the availability or lack of materials which are essential for this important component. Shortage of nickel may prove a problem in the manufacture of cathode sleeves, and may also affect availability of nickel iron as already noted. Alloys of high nickel content are likely to be available only for defense orders and substitution of existing alloys with low nickel and chromium content is urged wherever possible.

**Carbon Resistors.** Here, at least, is one component which does not offer the designer too many headaches. There is no bottleneck on carbon although limitations on copper, plastics and screw machine parts may require some design changes or other modifications.—B. D.



# .. New Subscription Order Card ..

Enter my new subscription to **ELECTRONICS** to start with the current issue. Bill me at the "special" rate of 3 years for \$10 — or the term checked below.

If you prefer 1 year - 12 issues - \$5 - check here

Name.....

Home Address.....

City and State.....

Firm.....

Position.....

(Subscriptions quoted for U. S. and Possessions, Central and South America)  
Canadian Rates: 1 year - \$5.50 — 3 years - \$11.00 — Payable in Canadian Funds at Par  
Printed in U.S.A.

6-41

FIRST CLASS  
PERMIT No. 64  
(Sec. 510 P. L. & R.)  
NEW YORK, N. Y.

**BUSINESS REPLY ENVELOPE**

No Postage Stamp Necessary If Mailed In The United States

4 Cents Envelope Postage Will Be Paid By—

**ELECTRONICS**

McGRAW-HILL PUBLISHING CO., Inc.

330 WEST 42nd STREET,  
NEW YORK, N. Y.





# INDUSTRIAL ELECTRONICS—I A PROGRESS REPORT

Five years experience with practical electronic equipment for industrial uses has taught many valuable lessons. Mr. Powers discusses the more important problems including the evolution from radio receiver practice to rugged construction necessary in industry

By RALPH A. POWERS

*Electronic Control Corp.*

**E**LECTRONIC engineering has made considerable progress in industrial plants during the past five years. What the industrial engineer has wanted, and has lacked, was learned by the electronics engineer through some unwelcomed experiences. At first, sheet metal housings usually associated with the radio business were used, but it was soon found that most of these units were either badly damaged or put out of production in a short time. More rugged construction was also required within the housing.

Probably only the largest production centers with rapid change over from one year's models to the next, offer the many heartbreaking experiences to the electronics engineer attempting to keep up the production and inspection engineers. Things must move rapidly and without a hitch (if this were only always possible).

Probably it would be well, first, to review a few electronic products, see how they have changed over the five years, and later go into a few special problems that had to be solved in a hurry.

## *Light Curtain Control*

An article showing the first attempts of combining photoelectric equipment with presses to insure operator safety, and at the same time increase production was published in the July 1937 issue of *ELECTRONICS*. The projector consisted of a number of individual lenses mounted in a

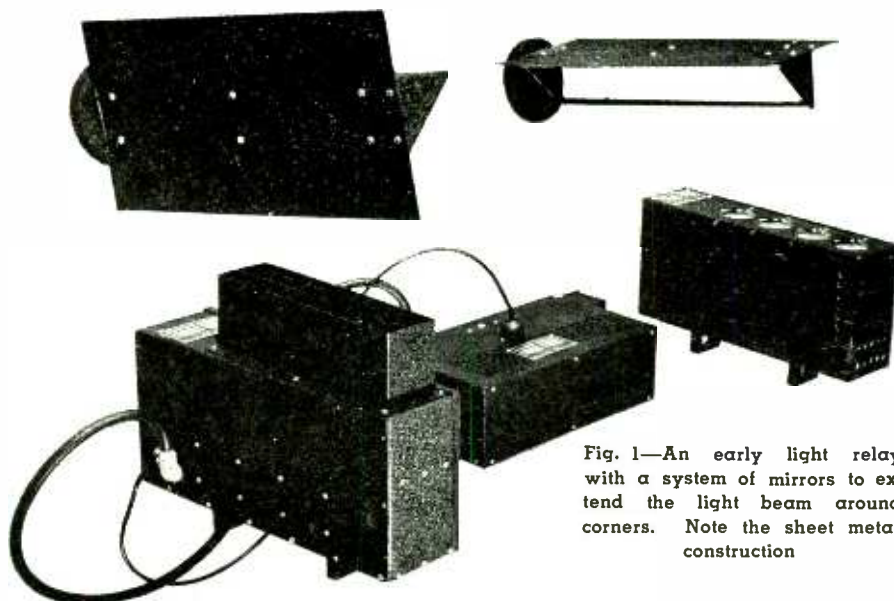
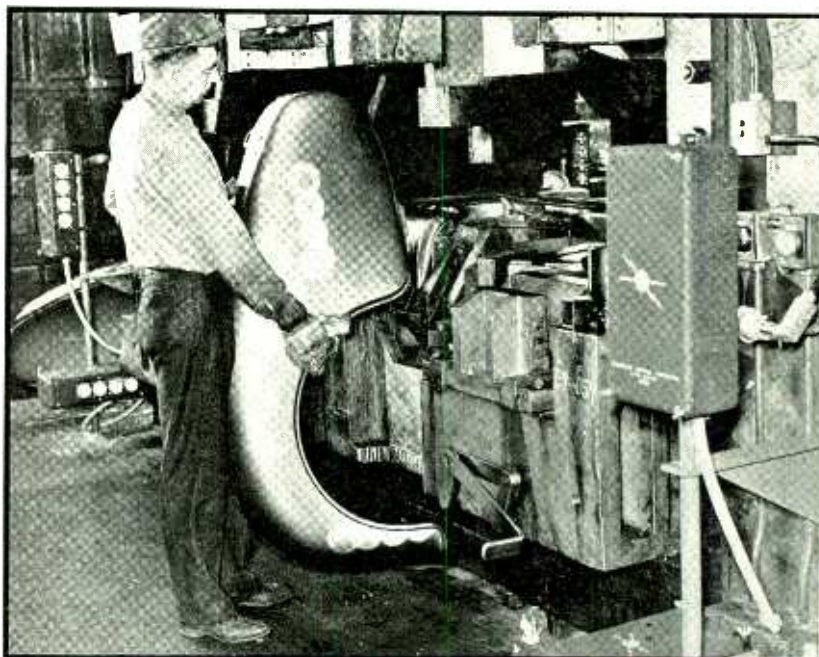

Fig. 1—An early light relay with a system of mirrors to extend the light beam around corners. Note the sheet metal construction

Fig. 2—In the interests of ruggedness, cast aluminum housings were used instead of the sheet metal housings. Two curtains of light are used here for greater protection of the operator





sheet metal housing and the corresponding lamps in order to obtain a frictionless barrier, 12 inches in height and 2 inches in thickness, around the operating sides of the press. The phototube housing was equally crude, with five long sheet metal light admitting tubes mounted in front of the five phototubes to minimize drift due to ambient light changes. The phototube housing was connected by cable to the amplifier. Unfortunately, the amplifier could fail, and not always on the safe side. This fact was not discovered until later designs were

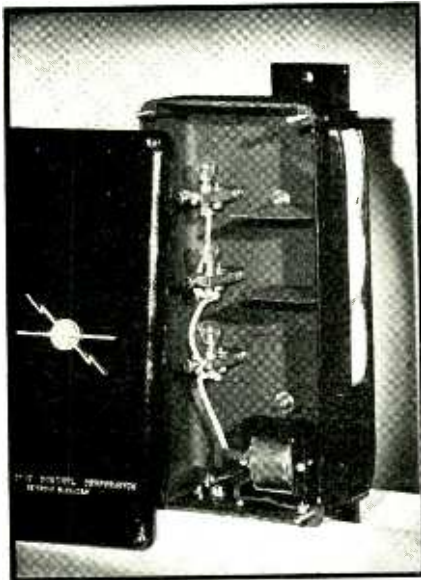

Fig. 4—Light curtain projector with rectangular shaped lenses cut from larger lenses and cemented to form a continuous light beam 12 inches high

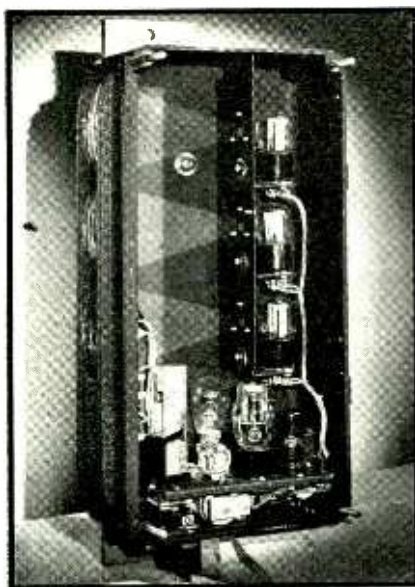

Fig. 5—Light curtain receiver with three plano-convex condensing lenses, adjustable pinhole apertures with expanding lenses, and three phototubes

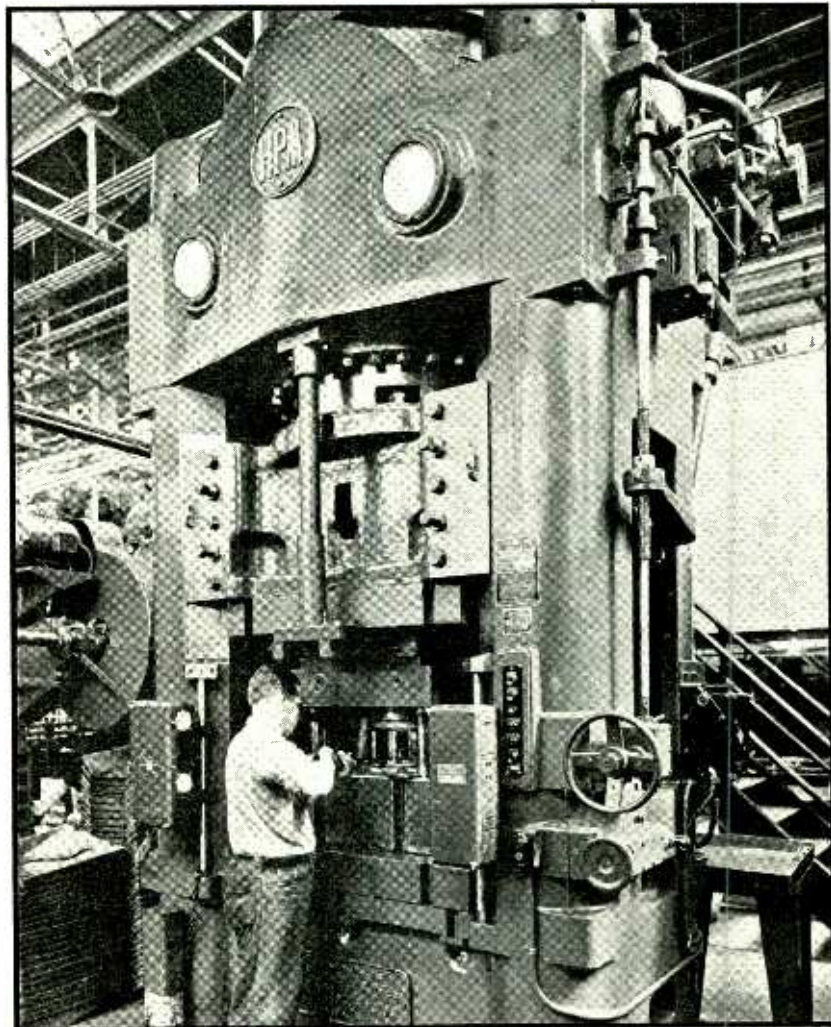

Fig. 3—Light curtain equipment installed on a hydraulic press. In this particular case, additional equipment is placed on the rear of the press for greater protection

worked out. The second light curtain equipment, incidentally purchased by the first user, was slightly better. Four lenses were used in the light curtain projector. Four phototubes with an improved optical system were contained in the phototube housing. As a result of several accidents that occurred to the first units it was felt that steps had to be taken immediately to place the units in cast housings. The complete set-up of second sheet metal housed units is shown in Fig. 1.

As more and more installations were contemplated, hurried plans were made to change over the unit assembly and within a very brief time cast aluminum light curtain projector cases and cast aluminum light curtain receiver cases, along with cast aluminum amplifier housings were available. Approximately the same optics used in the last sheet metal units were used in the new

cast aluminum housed units. A slight refinement was made in the phototube housing, where plano-convex lenses were used to focus their portion of the light curtain through individual optical slits to minimize the amount of extraneous light reaching these phototubes. Side light passing through the lenses would strike the optical plate either one side or the other of the slit, and not reach the light-sensitive area. A number of these units were installed similar to those shown in Figs. 2 and 3.

Improvements had to be made in the amplifier to make it fail as far as possible on the safe side. Failing on the safe side actually means opening the control circuit to the press, thereby stopping it in the event of: (1) inter-electrode shorts within the amplifier tube, (2) inter-electrode shorts within the phototube, (3) failure of light source, (4) open grid leaks, (5) faulty condensers or mis-



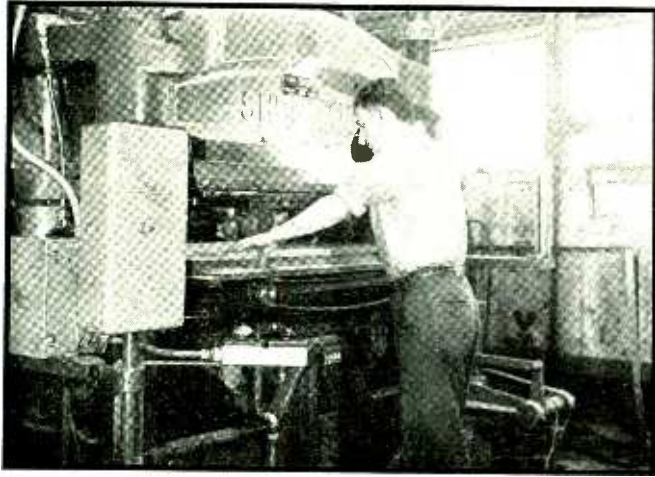
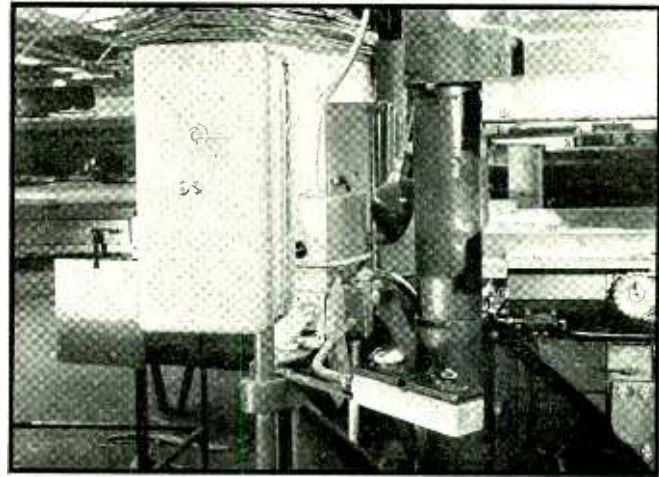
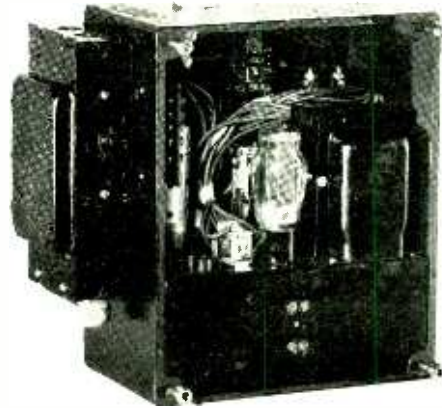
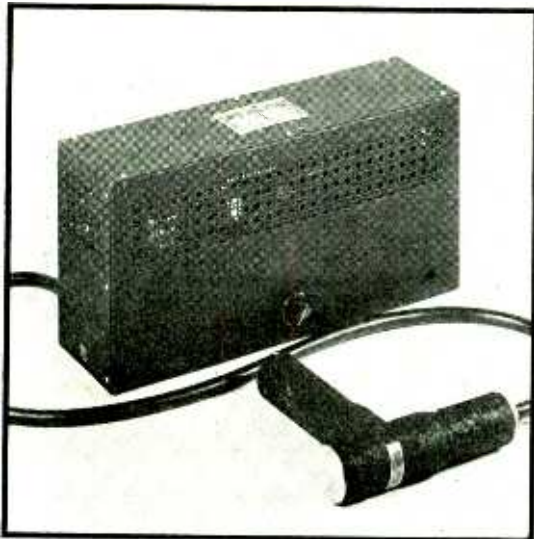

Fig. 6—The corner studs for holding the cover in place have been replaced in this recent installation with a single bolt in



the center together with a lock. Note that the light curtain extends around the press to protect it on all sides



Figs. 7, 8, and 9—Three stages in the design of amplifier housings. The sheet metal housing was first replaced with the cast aluminum housing. Then the corner studs were replaced with the lock and key to hold the cover in place

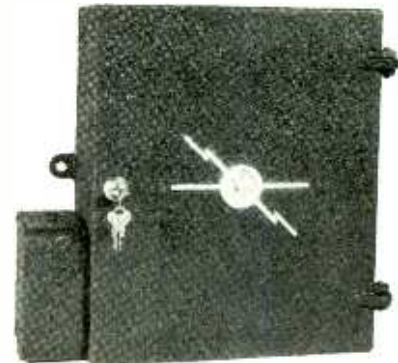

alignments of the units, or (6) large amounts of extraneous light reaching the phototubes from a work light or trouble lamp. First attempts at this were made by inserting very low current fuses in the plate circuit of the amplifier, and in series with the primary relay. This was found impractical because of the wide variety of installations, in which the length of the light beam varied from a few feet when shot across the front of a press, to several times this value where the light curtain had to be projected completely around a press.

While the units were now in cast aluminum housings and would stand far greater physical shock, the main assembly still consisted of three individual housings, one for the projector, one for the receiver or phototubes, and the third for the amplifier. The cords connecting the phototube

housing, or receiver, with the amplifier, were being continually broken off and plugs and jacks were not found satisfactory because an occasional wash down of the complete press resulted in water and moisture getting into the high impedance phototube line. It was decided on the next major move, in the latter part of 1939, to improve the optics and make the phototube housing and amplifier one unit.

The optical system of light curtain projector and receiver was greatly improved by having cut lenses made to order for the units. The lenses were cut in the form of rectangles, 2 inches wide by 4 inches in height from larger lenses. These lenses were cemented to each other (see Fig. 4) so that a continuous optical

system in a cast lens mount was available for both the projector and the receiver. The optical system of the receiver was further improved by introducing a small bi-convex lens behind each pinhole. The function of each one of these three lenses was to expand the image cast on its pinhole by the plano-convex receiving lens, and at the same time allow adjustment so that the image could cover the complete cathode of the phototube evenly and without overshoot light. This system is indicated in Fig. 5. The result of the complete

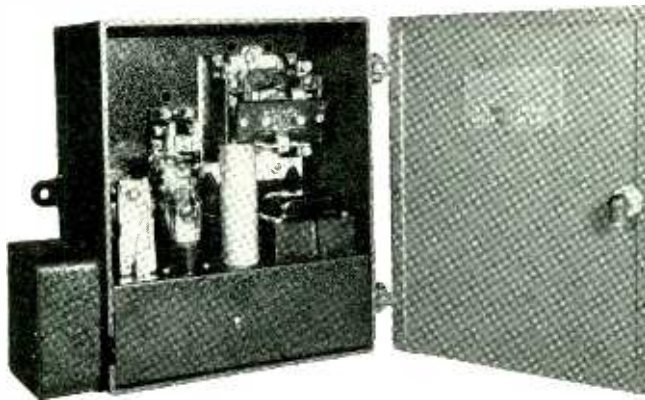

Fig. 10 — Interior view of the current model showing an electronic time delay unit mounted inside

change in optical system resulted in over-all sensitivity, such that if 10 percent of the cross-sectional area of the light is cut off, the press will stop.

The next major objective was to place the amplifier in the same cast housing with the phototubes, to make the light curtain receiver a completely self-contained unit, including the primary and secondary (power controlling) relay. When this was completed, the exterior appearance of the units were slightly changed, by removing annoying and clothes-catching thumb screws which held the covers in place, and by rounding off the corners. Pinned in place, a single center screw allows removal of the cover after it has been unlocked by authorized inspector or serviceman. A complete new set of units is shown in Fig. 6 as installed on a Sheridan Embossing Press. This installation includes electronic time delay for holding the press in full closed position during heated embossing operations.

The light curtain equipment has progressed during the past five years,

but now with European supply of lenses cut off, 1941 will see the optical system of the light curtain unit again altered so that a single automobile headlamp lamp will project a curtain of light, 12 inches high and a single phototube will receive the 12 inch curtain of light. The molds and tools for this new optical system are being completed in an American factory.

#### Two Stage Phototube Amplifiers

In 1935 a phototube amplifier of the two-stage direct-coupled type was produced in some quantities for controlling temperature in resistance heating of spark plug shells as they were pressed over the ceramic insulators, for controlling automatic rejection as the result of bounce of a scleroscope hammer, for gapping spark plugs, and for other similar installations where single stage units, commonly called light relays,

would not answer the problem. The single-stage units and most of the two-stage units then on the market did not offer great enough sensitivity to small changes of light. Again the units were in typical radio type housings of 16 or 18 gauge stock, finished in black wrinkle or crystal finish.

After a year, some of these units were returned, so battered that the filter condensers were knocked completely off the conventional radio type of chassis mounting. Other units looked as though a truck had run over them. If industrial plants were to continue the use of photoelectric equipment it had to be built to withstand more severe usage. The neat appearing, but not too rugged sheet metal housing is shown in Fig. 7, while Fig. 8 shows the first of a cast aluminum housing. Soon it was discovered that the thumb screws holding on the cover would catch wiping waste, or would catch on operators' clothes. When the cover was removed, the thumb screws were lost in the oil soaked sawdust around the base of the machine, so that eventually no covers were replaced in the field. It was not long before the amplifier would fill up with oil carrying steel or brass shavings, and then real trouble would develop. After this, drastic changes were made in the design of the housing and the several types of chassis used with them.

One of the first changes in the housing was to cast hinges on the cover and the main body of the con-

(Continued on page 89)

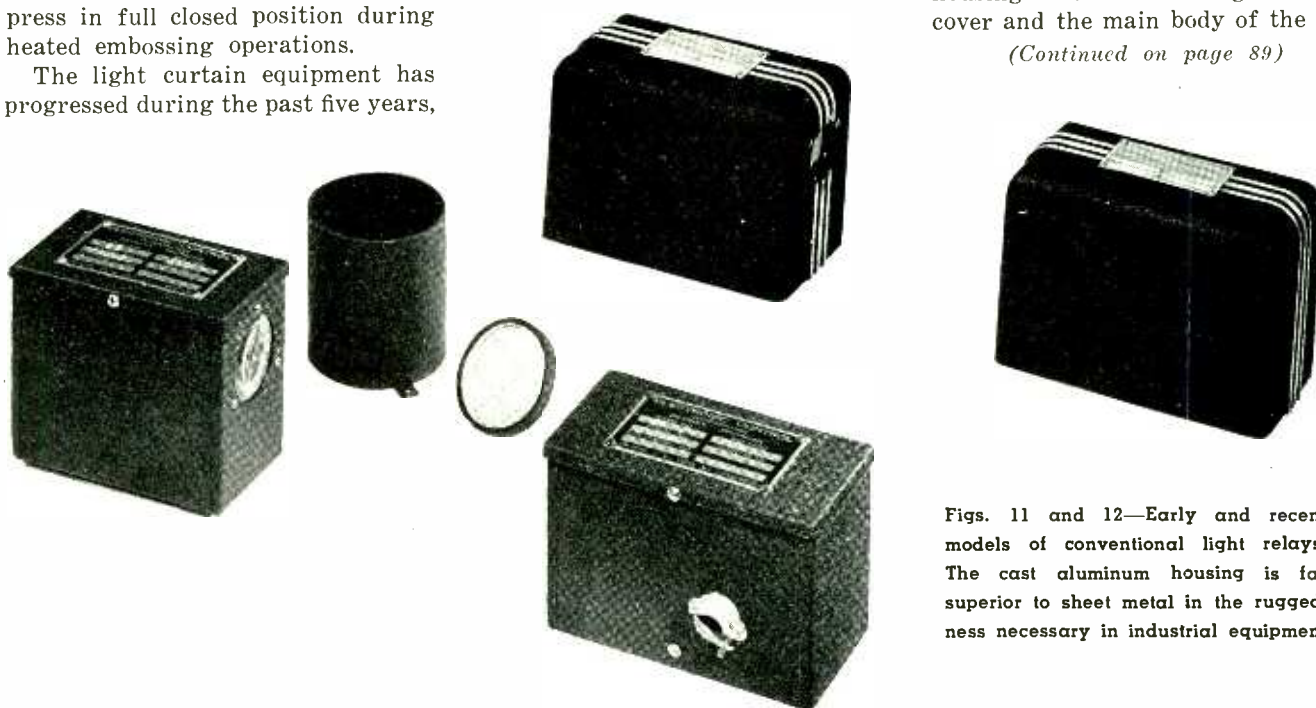

Figs. 11 and 12—Early and recent models of conventional light relays. The cast aluminum housing is far superior to sheet metal in the ruggedness necessary in industrial equipment



# Report on I.R.E. Summer Convention

Detroit was host to 350 engineers who discussed theory and circuits. Lecture on "Electronics in Medicine" and demonstration of artificial speech provided relaxation from harassment of priorities uncertainty and requests for technical aid for defense projects

**T**HE Summer Convention of the I.R.E., resumed this year in Detroit after a lapse of several years, attracted a group of some 350 engineers to the Hotel Statler to hear the presentation of 33 papers. The subjects covered included the popular topics of the day, frequency modulation, u-h-f improvements and television, as well as new transmitting and receiving tubes and industrial electronics. A seminar on "Electronics in Medicine," given by doctors on the staff of the Harper Hospital, Detroit, was the occasion of demonstrating various forms of brain-waves recorded on an electroencephalograph from the brain of a patient who was put under an anesthetic. At the banquet, Philo T. Farnsworth was awarded the Morris Liebmann Memorial Prize, and Prof. F. A. Firestone of the University of Michigan gave an entertaining demonstration of artificially recreated speech and music.

## *Call for Volunteers*

At the beginning of the first technical session, an appeal for volunteers to work as physicists and engineers at the Naval Research Laboratories was made while a representative of the British Embassy explained the needs of the British for volunteer American radio workers. The first technical paper "Photographic Analysis of Television Images" was presented by D. G. Fink, managing editor of *ELECTRONICS*. The paper described the use of a miniature camera with a fast lens in photographing television images under standardized conditions so that the average brightness of the image and its contrast range can be determined from density measurements made on the photographic negatives.

The second paper of the Convention was delivered by Ralph A.

Powers of the Electronic Control Corp., Detroit, who spoke on "Industrial Electron Application." Mr. Powers' talk covered essentially the same ground as is contained in his article in this issue, to which the reader is referred.

An unusual application of the principles of radio was given by C. I. Bradford of the Remington Arms Company, Bridgeport, Conn., who described a radio frequency oscillator in which the presence of a metallic object in a link-coupled coil produces reactions in the oscillator circuit which are used to determine velocity measurements. The principal engineering problem is that of obtaining sufficient reaction on the oscillator from the relatively small metallic object, and to obtain this required signal consistently when a bullet is at a known fixed point with respect to the coil.

R. L. Campbell presented a joint paper prepared with R. E. Kessler, R. L. Rutherford, and J. G. Langford,

of DuMont, in which it was shown that while portability is a necessary requirement to outside pickup equipment, several advantages result when probability is applied to equipment used in the studio. To equip a studio of adequate size with fixed equipment for operation of several cameras involves considerable time and expenditure. However, with portable studio equipment, the entire installation can be located to meet studio needs, and can be moved to different studios or outside.

Messrs. Alford, Kandoian, and Hampshire of the International Telephone Development Company, discussed arrays of several horizontal loops stacked one above the other at a vertical separation of about three-quarters of a wavelength. Each loop is a single wire in the form of a horizontal square structure, with two condenser plates at each corner. These plates bring the current maxima out to the proper points on the sides of the loop to



F. E. Terman, President of the Institute of Radio Engineers for 1941 makes presentation of the Institute's Morris Liebmann Award to Philo T. Farnsworth for his contributions to the development of the science of electronics

produce the circular pattern. The condenser plates are adjusted until the proper radiation distribution is obtained. The authors explained that this adjustment is not critical and can be made directly from simple measurements, so that virtually no adjustment is necessary in the field.

Dr. G. H. Brown of the RCA Manufacturing Company presented a paper disclosing a method of removing the difficulties in the turnstile antenna, so that no turnstile element adjustment whatever is required in the field. Each displays a constant value of radiation resistance over a band about 1 Mc wide. Adjacent legs of each turnstile element are fed through coaxial segments attached directly to the side of the elements, one segment being inductive, the other capacitive. The array is assembled on the ground, with the mast in a vertical position. The array is then rotated about the mast as an axis to obtain the horizontal radiation pattern.

As a result of developments in frequency modulation many state police and public utility groups now feel it possible to have sufficient range of operation to make two-way systems economically feasible, according to F. T. Budelman. The fundamental advantage of frequency modulation is freedom from noise, although the ability to modulate the transmitter at low power levels and to use high efficiency amplifier stages which increases the overall efficiency of transmitters so that more power can be delivered to the antenna than by a-m transmitters of comparable size, power input, and price is also an important practical consideration, especially in emergency communication. Instead of the greater amount of upkeep and service originally expected of frequency modulation equipment, many hundreds of units in service have shown the opposite to be the case.

N. C. Olmstead and A. A. Skene of the Bell Telephone Laboratories described a new 10-kw f-m transmitter which uses a single tube in the final amplifier, a type 389AA tube designed for forced-air cooling. The principal problem in the 10-kw amplifier design was to reduce the effect of the residual capacitance in the plate circuit (made especially large by the cooling structure) which tends to introduce excessive losses or distortion due to improper

band-pass characteristics. The circuit finally adopted consists of a cathode-output amplifier, the plate being tied to ground through a bypass condenser which shunts the stray capacitance in the plate circuit.

#### *F-M Frequency and Modulation Monitor*

A monitor which measures the average frequency of an f-m transmitter during modulation, and which also serves as a modulation indicator was described by H. R. Summerhayes, Jr. of the General Electric Company. The monitor is essentially a precision type of f-m receiver, with crystal-controlled local oscillator, and a separate crystal oscillator for calibration purposes. The monitor element proper is a discriminator or frequency detector with a highly linear characteristic. The discriminator has been modified by reversing the polarity of one of the diode elements to increase its current-output sensitivity. A d-c meter in the discriminator output indicates the difference between the average frequency of the received signal and the standard calibration frequency.

That distortion in frequency-modulation systems may arise in the modulator in the discriminator-detector, and in circuits through which the signal must pass was shown by N. I. Korman. It has been found that in practical systems, the distortion may be estimated quite accurately and comparatively easily by using the instantaneous-frequency concept. Furthermore, it has been found that at all but the highest audio frequencies, only the amplitude characteristic is of importance in the production of distortion.

"Phase distortion", which is generated in the radio frequency interstage coupling networks, is found to be relatively unimportant even though the harmonic distortion products are not negligible. The reason for this is that the intermodulation-distortion products are found to be negligibly small, and the harmonic distortion products are of such high frequency as to be inaudible.

H. Busignies described the development of a method enabling pilots to determine the accuracy of night bearings obtained by means of a radio compass in the wavelength range of 200-2,000 m (1,500-150 kc). Study of the dynamic aspect of the night error shows that despite the com-

plexity of the compounded reflected field, the indications of a radio compass on an airplane will oscillate regularly around a mean value, generally somewhat incorrect. Nevertheless, the accuracy obtained is within a third or a quarter of the total amplitude of oscillations of the indication ( $\pm 5$  degrees if oscillations of 15 degrees to 20 degrees occur).

An ingenious method of changing the frequency of a complex wave without altering its wave form was described by E. L. Kent of C. G. Conn, Ltd., in a combined lecture-demonstration presented with motion pictures containing animated drawings. The method may be regarded as one in which very short sharp pulses, generated in an oscillator are combined with the complex wave such that the pulses may be regarded as "sampling" the complex wave.

The frequency changer may be explained by calling it a special case of heterodyne action in which the complex wave is beat with a pulse wave rather than with a sine wave as is usually the case.

The pulse wave is generated by a blocking oscillator whose output is fed to one control grid while the complex wave is applied to the other control grid of a pentagrid converter. The converter output contains the difference frequencies of the complex and the pulse waves. It was shown that if a pulse wave having 100,100 pulses per second is beat with a complex wave of 100,000 cps fundamental frequency and having harmonics up to and including the fifth the audio difference frequencies in the output circuit will be 100, 200, 300, 400 and 500 pulses per second, which are harmonically related. If distortionless detection is used the amplitude of the harmonic in the 100-cps wave will be proportional to the amplitude of the corresponding harmonics in the complex wave whose frequency was changed.

#### *Air-Cooled Transmitter*

Fred W. Fisher described a new air-cooled 5-kw broadcast transmitter recently designed and manufactured by Westinghouse, for use in a standard broadcast band of 550 to 1500 kc. Design emphasis has been placed on the incorporation of a low audio distortion characteristic and a flat frequency response. The transmitter is fully air cooled.



Lincoln LaPaz and G. A. Miller defined the theoretical optimum current distribution on a vertical antenna of given length as that current distribution giving the maximum possible field strength on the horizon for a given power output. The determination of such distributions is a problem in the calculus of variations. Solution functions, derived for antennas varying in length from  $\lambda/8$  to  $\lambda$  were shown as current distribution figures. These distributions are of value because: (1) the apparent antenna performance obtained with a theoretical optimum distribution is as good as, or better than, that obtained with any practical distribution, and thus serves to bound the improvement in antenna performance which may be expected in the future as a result of changes in current distribution, and (2) the theoretical optimum current distribution gives an indication of the general class of distributions most likely to yield worth-while results in a search for practical optimum distributions.

"Shortwave Broad Band Receiver Circuits" were discussed by D. E. Foster and Garrard Mountjoy of RCA License Laboratory.

For receivers with capacitance tuning in the broadcast band, an expensive but good method of tuning the oscillator is to include the separate small oscillator sections in the main condenser of one stator and one rotor plate. This method of tuning gives even distribution of stations over the dial. For receivers with inductance tuning an extra oscillating tuning coil of small inductance and small percentage change may be used with the main tuning mechanism.

The success of such a system depends upon suitable preselector circuits which discriminate against spark noises, gives reasonable gain when used with a low capacitive antenna, provides freedom from microphonics, and permits slight changes in antenna capacitance without corresponding change of frequency of the oscillator.

H. E. Rice of the Stromberg Carlson Telephone Manufacturing Co. described the design and development of a method of aligning and testing frequency modulated receivers under factory production conditions, involving rapid means of securing a quantitative limit check, comprising

sensitivity, fidelity, and distortion.

A battery-operated oscillator, with a motor driven tuning condenser provides the fundamental 4.3 Mc frequency-modulated signal. The output is amplified and fed to a balanced 150-ohm line whose output level is controlled by varying the screen voltage of the buffer amplifier. A diode voltmeter indicates the voltage of each line. A portion of the oscillator output is fed to the signal grid of a 6SA7 tube, whose oscillator section functions as a 75 kc oscillator. The output, coupled through two tuned circuits, provides 75 kc deviation frequency of the 4.3 Mc carrier. The equipment contains three audio generators of 70, 400 and 10,000 cycles per second, with meters to indicate the output voltage. The rack containing this equipment is placed in a shielded room and special precautions were taken in grounding to minimize radiation. All test equipment is operated from batteries or from regulated supplies.

D. L. Waidelich's paper, "The Full Wave Voltage Doubling Rectifier Circuit," gave an analysis of the full-wave voltage-doubling rectifier with the main assumption that the tube drop is zero when conducting. Material presented was closely related to Mr. Waidelich's article in the May 1941 issue of *ELECTRONICS*, although the principal conclusions are shown on the attached graph. It is shown that polarized electrolytic condensers should be used only so

long as  $\omega CR$  is greater than 4.794, while non-polarized condensers may be used for any value of  $\omega CR$ .

Hillel Poritsky of the General Electric Co. discussed the transmission characteristics presented by a row of equidistant similar plates to plane electromagnetic waves. A solution of the problem is an algebraic equation of the second degree; when the roots of this equation are complex, the row of plates transmits the plane wave, whereas when the roots are real, they do not. Thus, the row of plates may be regarded as the equivalent of an electric wave filter having attenuation for certain frequencies and transmission for other frequencies. The use of a series of equidistant, similar glass plates and alternate air gaps as a selective shield was brought out in a discussion between Mr. Poritsky and Harold A. Wheeler.

The problem of designing transmission lines from theory, based on correct and effective means of analysis, was discussed by Simon Ramo. Mr. Ramo showed that: (1) some tapered lines may be exactly analyzed on the conventional distributed constant basis, (2) in general, tapered lines cannot be treated except approximately by the conventional transmission line equation due to the existing field configurations, (3) the conventional transmission line equations should give good approximate results in all cases if the distance between lines

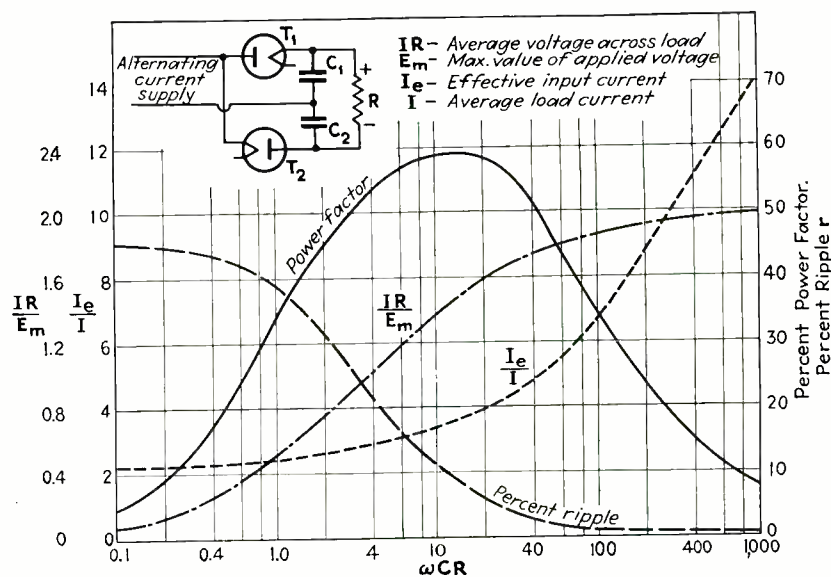

Operation of voltage doubler as function of load ( $\omega CR$ ) where  $C$  is the capacitance of either  $C_1$  or  $C_2$ , both of which are equal

is small compared with the wavelength, and (4) the ability of a tapered line to give electrical characteristics differing markedly from those of uniform lines does not depend upon a taper being such as to require the consideration of mutual effects.

A simple, portable, and ingenious method of determining the horizontal directivity pattern of an antenna array was given by W. G. Hutton of WGAR who described his mechanical calculator for directional patterns. The calculator, which is about three inches thick and approximately 30 by 36 inches in area, is provided with portable legs so that the unit could be used in the field as well as in the laboratory. Functionally, it consists of a horizontal, plane table provided with mechanical means of constructing to scale in proper magnitude and phase, the various vector voltages encountered in analyzing a three-element array. Adjustments are provided to take account of the spacing of the elements, the voltages on the elements, and the phase relations between the elements. When the calculator is properly set up, corresponding to the conditions which occur for the array under consideration, the directivity pattern is traced out in a very short time, without tedious calculations.

An extension of the theory of radial space charge flow between concentric cylinders by W. G. Dow of the University of Michigan and A. B. Bronwell of the Northwestern Technological Institute, was delivered by Professor Dow. A simple form of the general differential equation governing the unidirectional flow of space charge was obtained by introducing a parameter which takes into account the transit time. It was shown that any tube problem involving radial configuration might be considered as falling into one of the following cases: Case I, involving a minimum in the potential distribution; Case II, in which the potential distribution curve rises from zero with finite slope; and Case III, the complete space charge condition.

Some new theoretical and experimental methods of determining the characteristics of electron lenses were described by Karl Spangenberg and Lester M. Field. The experimental method is simpler in application and more accurate than pre-

viously proposed methods. It makes use of angular magnifications measured from shadows cast by object screens illuminated by a point source of electrons. Data on the focusing characteristics and aberrations are obtained simultaneously. The method does not require screens movable in a vacuum nor the generation of rays parallel to the axis. Measurements were made with a demountable vacuum system.

W. G. Shepherd of the Bell Telephone Laboratories, described some experiments on a circuit which permits the production of current discharges of short time duration at relatively high base or fundamental frequencies. Since such discharges are rich in harmonics at the base frequency, such a device has many uses such as a generator of carrier frequencies or as a means of producing the spectrum of standard frequencies for the purposes of calibration.

C. E. Haller of the RCA Radiotron Division described three new low-power transmitting tubes for the u-h-f region. Type 829 is a push-pull beam tetrode, two structures in a single envelope, capable of 50 watts carrier output at 200 Mc. Tungsten lead wires, which serve also as terminal pins and support rods, are sealed through the glass-plate base of the tube. Type 815 is a similar duo-beam-tetrode tube of lower power, 30 watts carrier at 120 Mc. The 826 is a triode, which will deliver 60 watts as high as 250 Mc. Both the 829 and the 826 require forced air cooling for full power operation at the highest rated frequency.

A new series of u-h-f receiving tubes designed to offer service comparable with the acorn tubes but at less cost was revealed by L. B. Curtis of the RCA Radiotron Division. These tubes employ the base and sealing technique of the miniature tubes developed in 1939 for the miniature (camera-type) personal radio receiver, and which have been put into quantity production. Type 9001 is a remote cut-off pentode,  $g_m$  1400  $\mu$ mhos; type 9002 a triode,  $g_m$  2200  $\mu$ mhos; 9003 a sharp cut-off pentode,  $g_m$  1800  $\mu$ mhos. The tube dimensions are approximately  $\frac{3}{4}$  inch in diameter by  $1\frac{1}{2}$  inches high overall.

Trends in receiver tube manufacture, discussed by R. L. Kelly of

the RCA Radiotron Division, included increase in  $g_m$  without decreasing the grid-cathode spacing or increasing the heater current, made possible by the use of a flattened cathode structure. The recent announced 6SG7 pentode is a tube of this type having a  $g_m$  of 4000  $\mu$ mhos, compared with 2000  $\mu$ mhos for its predecessor, the 6SK7, which has the same heater rating and grid-cathode spacing. Another tube of interest is the 6SF7, a diode pentode used with the pentode as an i-f amplifier and the diode as detector. Still another new tube is the 45Z3 rectifier designed to permit a-c/d-c operation of the "personal" battery-operated portable sets.

G. D. O'Neill of Hygrade Sylvania Corporation gave a mathematical analysis of the effect of contact potentials, and other potentials which cannot be measured directly, on the design and rating of tubes. Four equations were presented for the triode, which permit the evaluation of these internal potentials, and which aid greatly in the rating of tube operating conditions. As a practical example of the effect of the contact potential, 10 tubes, type 6Q7GT, were put on life test for 500 hours. At the end of this period the emission remained unchanged, the  $g_m$  had dropped 8.8 per cent, and the plate current (for a given grid bias) had dropped 52 per cent. The latter change was accounted for by the change in contact potential from an initial value of 0.780 volts to a final value, after 500 hours, of 0.140 volt.

The problem of calculating the performance of a plate-modulated amplifier when self-bias is used in the grid circuit was analyzed by R. I. Sarbacher, of Illinois Institute of Technology. Dr. Sarbacher showed that the dynamic characteristic may be traced out comparatively simply when fixed bias is used, since the quiescent carrier point then runs up and down the  $e_c$  axis on a straight vertical line. When the bias depends on excitation or modulating level, however, a much more involved graphical construction is necessary, and in general the quiescent point runs along an oblique line to the left or right depending on the source of bias voltage. A complete solution for each case was shown to be possible in a step-by-step analysis once the tube characteristics, excitation,



modulation and bias conditions were known. The analysis involves plotting and replotting several families of curves.

Albert Rose of the RCA Radiotron Division presented a comparison of the relative sensitivity of the human eye, photographic film, and television pick-up tubes. The "ideal" pick-up device, which displays the theoretically highest sensitivity, is one whose picture elements are actuated by the arrival of a single quantum, producing a picture just equal to the threshold level of perception. The eye requires about 100 quanta to excite a single picture element (the rods or cones), that is, it is 1/100th as sensitive as the ideal. Film in the ideal case also requires about 100 quanta per exposed grain, but since the effective resolution of film is based on clusters of grains, film has considerably lower sensitivity than the eye in practical operation. The best storage television pick-up tubes now currently available require about 100,000 quanta per picture element for threshold pictures. This sensitivity is 1/100,000 of the ideal case, and about 1/1000th that of the eye. However it compares favorably with film under operating conditions.

The paper by Kell, Bedford, Fredendall and Kozanowski of RCA at Camden revealed a new technique of analyzing the response of a television system by recording its response to a 100,000-cps square wave. A 100-kc square-wave generator and oscilloscope, with a marker circuit which suppresses the oscilloscope trace every 1/20th (or 1/30th) microsecond, was used to obtain the square-wave response curve. From this response curve the steady state (amplitude and phase vs frequency) curves were obtained by a graphical technique which is believed to constitute a new mathematical tool. The square-wave response is divided into the sum of a number of square waves, having different relative amplitudes and different relative initial phases, depending on the shape of the response curves. Since the frequency content of each of these waves is identical, the circuit response to any frequency may be taken as the vector sum of the relative amplitudes and phases of the square-wave components. A vector chart for performing this operation has been devised. The reserve proc-

ess of synthesizing the square-wave response from the steady state response curves was also disclosed.

Murray G. Crosby discussed the distortion encountered when frequency modulation is transmitted over a multi-path medium such as that involved in the propagation of radio waves refracted by the ionosphere. The effect of the multi-path transmission is to introduce a new modulation frequency which is frequency modulated from zero to frequencies as high as twice the applied frequency deviation. The new frequency, therefore, has no harmonic relation to the original modulation frequency, so that its annoyance factor is very great. The amplitude of the distortion is proportional to the variable modulation frequency of the distortion component and may rise to a resultant peak frequency deviation as high as approximately twice that of the original modulation frequency.

H. B. Deal, RCA License Laboratory, discussed and demonstrated the general method of operation of counters and their application to a time unit for television synchronizing signal generators.

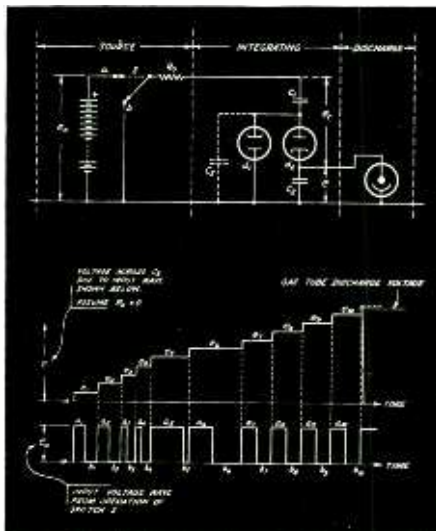

Fundamental circuit of counter in which each successive pulse increases the voltage across  $C_2$  until gas tube discharges

Particularly advantageous features of this circuit are that the frequency of the source voltage need not remain constant, and that frequency division of any integral values from one up to fairly high values are possible. Frequency division as much as sixty times has been accomplished, although it is better practice to use lower values of not

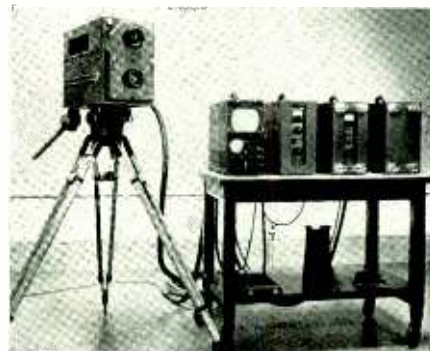

RCA portable television pick-up equipment employing orthicon tube

more than about 15 or 20. The fundamental circuit described by Mr. Deal may be considered as one in which the frequency of the source voltage is converted into a varying voltage which increases in steps for each alternation of the source voltage.

Considerable field experience with the iconoscope portable television equipment has indicated a need for camera equipment which produces satisfactory pictures under very unfavorable lighting conditions. It was thought that the orthicon, with its superior sensitivity, could be used in portable equipment to obtain the desired results. M. A. Trainer described the construction of orthicon portable television equipment made by RCA and weighing 270 lb. and requiring a power of 1,250 watts. The equipment consists of an amplifier and view finder compartment together with orthicon mounted on a tripod, a gamma control unit, a power supply unit, a synchronous generator shaping unit, and a synchronous generator pulse unit. Among the features of the design are the use of a forced air-cooled transformer in the regulated power supply unit, and power electronic synchronizing generator, gamma control, and keyed diode for black level setting. A general view of the equipment, together with a close-up of the camera are shown.

The master control unit for use with two or three orthicon cameras is under construction and it is believed that the equipment described by Mr. Trainer is expected to fill a need for equipment to be used where artificial or natural light is insufficient for satisfactory iconoscope pictures, which condition is frequently encountered in televising sports events inside, or during the late afternoon.—B. D. and D. G. F.

# Variable Equalizer Amplifier

The variable gain-frequency characteristics of this amplifier permit the reproduction of records made under a variety of recording conditions to obtain the maximum fidelity consistent with recording characteristics and the signal-to-noise ratio of record material

By HENRY RAHMEL

*Blackett-Sumple-Hummert, Inc.*

**T**HE Federal Communications Commission has recently recognized that technical developments have improved electrical transcriptions to the extent that they may rival performance of live broadcasts. However, transcription reproduction which takes full advantage of technical developments tending toward greater fidelity has become difficult to achieve because of non-standardization of recording techniques. Today there are several dozen commercial companies, in addition to many radio stations, recording material for broadcast purposes. The various recording characteristics employed constitute what is perhaps the most serious obstacle to a radio station obtaining the utmost in fidelity from transcriptions. If a reproduction system is properly equalized for transcriptions recorded by one manufacturer, there are many instances when such equalization is wholly unsuited to transcriptions from other sources. This article discusses this

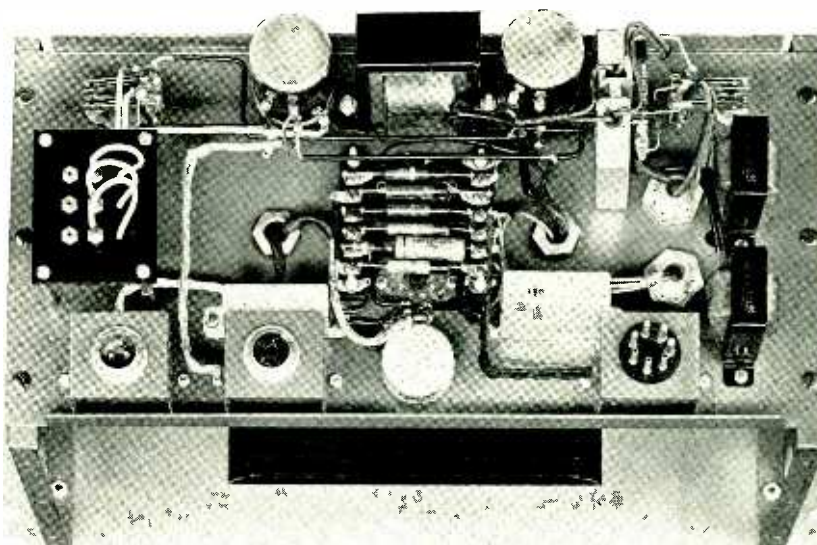

General view of the base on which all parts are mounted. This unit may also be used as a straight high quality amplifier

problem and its solution. It includes an outline of typical recording characteristics, an analysis of related reproduction problems, and the description of an adjustable reproduction equalizer system which has proved to be an entirely satisfactory solution to the problem.

There are two independent variables in the recording characteristics currently employed: (1) the low-frequency constant-amplitude characteristic, and (2) the high-fre-

quency or pre-distortion characteristic. The low-frequency characteristic may vary with regard to slope or curvature, as well as cross-over frequency, as indicated in Fig. 1. This variation is largely inherent in the recording heads in use, because relatively few organizations equalize or otherwise alter the low-frequency performance of their recording heads. Typical high-frequency characteristics are shown in Fig. 2. Here likewise the unequalized performance of several recording heads is shown, along with several equalized or pre-distorted characteristics. Most radio stations record solely on acetate, and accordingly have not experienced the need for high-frequency pre-distortion because of the inherent low noise-level of the better instantaneous materials. The majority of commercial companies utilize some form of pre-distortion in order to maintain a satisfactory signal-to-noise ratio on pressings without sacrificing quality.

The recording characteristics em-

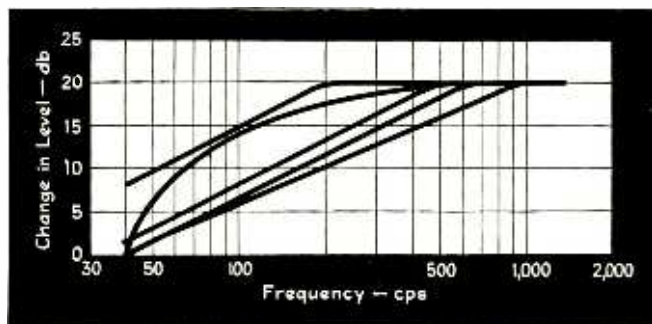
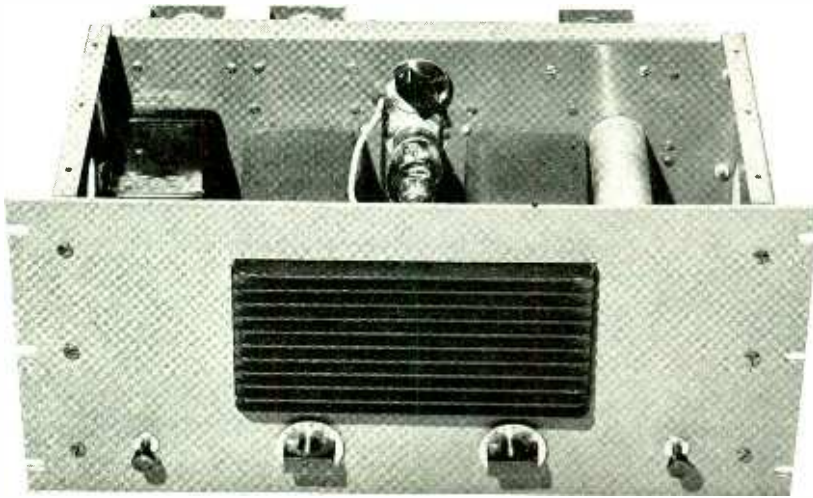

Fig. 1—Recording characteristics of several commercially available instruments illustrating the need for properly accentuating the low frequency response





Panel view of rack-mounted equalizer with tubes accessible through grille. By the use of this device the maximum quality available on a record is reproduced

ployed by several commercial transcription manufacturers are shown in Fig. 3. These data, as well as those of Figs. 1 and 2, indicate the need of reproduction systems with widely adjustable post-distortion equalizers. Where sufficiently flexible reproduction facilities are not available, quality and signal-to-noise ratio suffer. Improper reproduction is responsible to a considerable extent for the general maligned accorded transcriptions by station technicians, advertising people, and program sponsors, many of whom have come to feel that an electrical transcription is a necessary evil to be avoided insofar as possible. This statement is not intended to imply that there has been a dearth of poor transcriptions, but recording stand-

ards for the most part have improved because of the general increasing emphasis on fidelity. Reproduction equipment must keep pace with the developments in recording technique if the advantages of the latter are to be realized.

About two years ago the writer began the development of an adjustable post-distortion unit of sufficient flexibility to permit proper reproduction of the variety of transcriptions that had become part of everyday routine. A finished design has been in use, and rendering satisfactory service in several locations for two years. The following are the conditions for which the unit was designed.

(1) Variable response to afford

transmission characteristics complementary to the range of recording characteristics shown in Fig. 3.

(2) Minimum reproducer sensitivity about  $-60$  db (6 milliwatts, 500-ohm reference level); reproducer impedances: 5, 30, 50, 200, and 500 ohms.

(3) Post-distorter output: minimum level,  $-20$  db; output impedance, 500 ohms.

(4) Reproducer response essentially flat (when driven by a constant velocity reference source) over the desired range; 80 to 5,000 cps minimum, 30 to 10,000 cps preferable.

Item (1) needs no further discussion. Item (2), minimum reproducer sensitivity, was placed at  $-60$  db for design purposes. This value is not arbitrary, but is based upon knowledge of available transcription reproducers. The range of impedances specified was determined by the ratings of commercial magnetic units; crystal reproducers usually operate at sufficiently high levels to permit dropping to 500 ohms by means of a simple resistive divider. Item (3), output-level and output-impedance values, were chosen to permit operation into conventional monitor-mixer systems.

The flat reproducer specification, Item (4), is standard for the manufacturers of transcription reproducers, excepting only those of piezoelectric units and these are readily equalized to this standard. However, measurements of reproducer frequency-characteristics are rarely in

Fig. 3—Typical transcription recording characteristics. Non-uniform response for each curve and lack of standardization are readily apparent

Fig. 2—Recording characteristics of commercial equipment at high audio frequencies, again illustrating the desirability for controlled amplifier gain

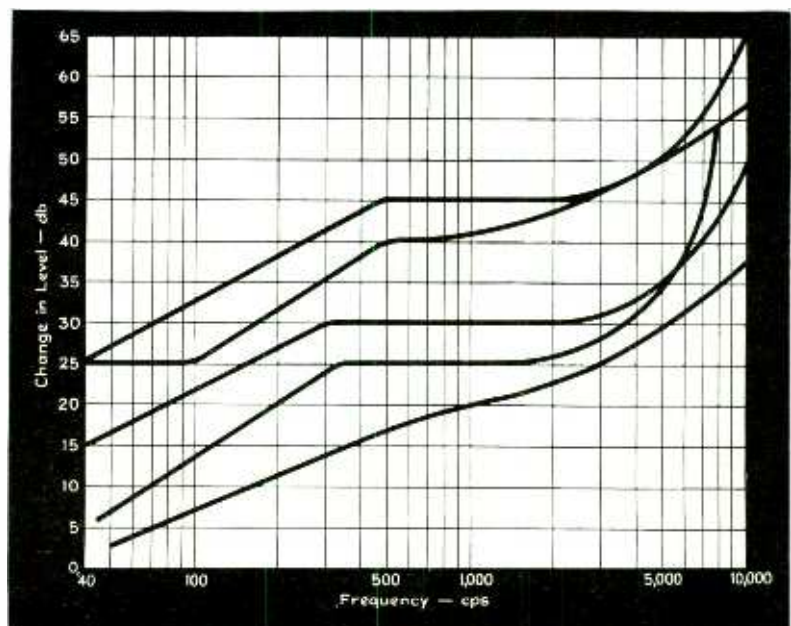
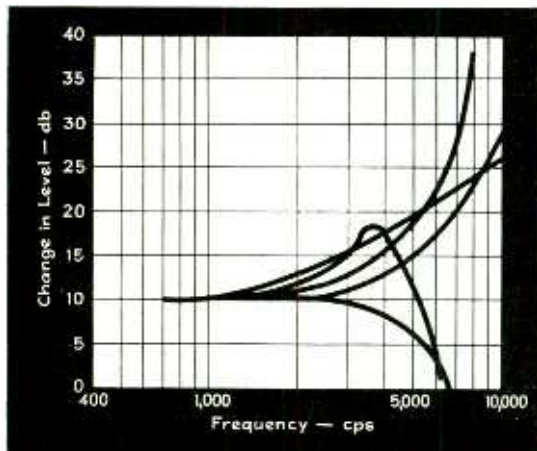





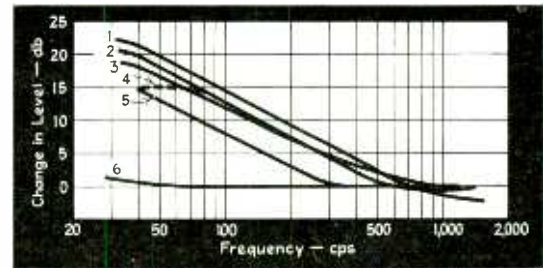
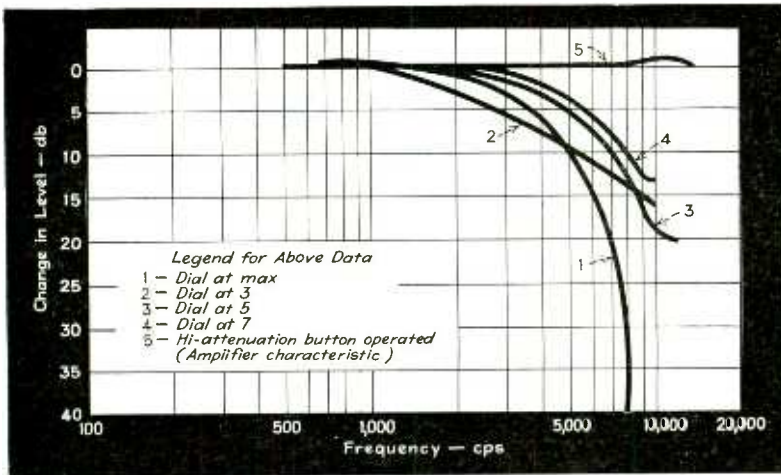

Fig. 6—Low frequency compensation curves for various adjustments of the equalizer

Fig. 7—High frequency attenuation curves for various adjustments of equalizer

ings to minimize hum and noise pick-up. Extraneous low-frequency disturbances are of necessity maintained at especially low levels because of the bass boost afforded by the low-frequency equalization section. The frequency response of the amplifier is uniform within 2 db from 20 to 15,000 cps. The total harmonic distortion is less than 2 per cent at any frequency in the above range with the amplifier operating at normal levels.

The low-frequency equalizer section is of the bridged-T resistance-controlled type. The circuits are broadly resonant at 40 and 80 cps. Tests have shown that 40 cps is sufficiently low to take advantage of the fidelity capabilities of commercial transcriptions. If the point of maximum rise is reduced to 25 cps or lower, mechanical disturbances in-

troduced in recording or reproduction are frequently amplified to the point of being objectionable. There is also the additional insertion loss consideration. A family of performance curves indicating the scope of compensation characteristics available from the low-frequency equalizer are given in Fig. 6. The maximum compensation is about 22 db. It is significant that control of the slope between 1,000 and 500 cps has been provided ( $R_1$  in the schematic diagram is the variable in curves 2 and 3 of Fig. 6). The desirability of this flexibility has been pointed out in the previous discussion of recording characteristics. A further control of the low frequency variables is provided in  $S_1$  which permits choice of rising or flat characteristics below 100 cps (as required by recording practice). A comparison

between Figs. 3 and 6 reveals the exactness with which the available low-frequency reproduction characteristics match typical commercial recording characteristics.

The high-frequency attenuation section is also of bridged-T configuration and is likewise resistance controlled. The various attenuation characteristics provided are shown in Fig. 7. This family of characteristics is available at each of three cut-off frequencies: 4, 6, and 8 kc. The 6-kc cut-off frequency permits choice of suitable high-frequency attenuation characteristics for many commercial transcriptions (compare Figs. 3 and 7). The 8-kc cut-off point is useful when frequencies above 7 or 8 kc are available on record materials affording satisfactory signal-to-noise ratio at wide audio acceptance bands. The writer's experiments to date indicate that the better commercial equipment and materials permit reproduction up to 12 kc. These studies have been conducted with an eye toward f-m applications.

The 4 kc cut-off frequency provides reproduction characteristics suitable for phonograph records (which are pressed in shellac) and the cheaper, filled-material transcription pressings. The reproduction characteristic for this type service is determined primarily by the inherent signal-to-noise ratio of the pressing material. When the compound is made up of abrasive fillers and binders (as contrasted with pressings of homogenous materials such as vinyl acetate or one of the resin esters), the inherent surface-noise is such that the audio bandwidth must be materially reduced. A reproduction characteris-

(Continued on page 61)

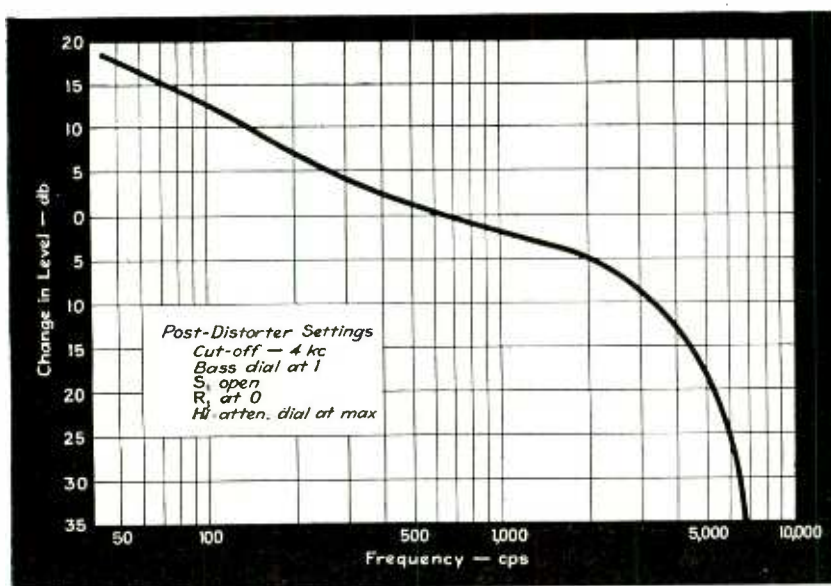

Fig. 8—Phonograph reproduction characteristic for adjustments indicated. This characteristic is suitable between fidelity and signal-to-noise ratio for shellac phonograph records

# CBS Goes to LATIN AMERICA

Engineering factors in the construction of new CBS short-wave transmitting stations at Brentwood, L. I. for transmission to Central and South America as well as to Europe. Two 50-kw transmitters, operating in each short-wave band and having facilities for instantaneous frequency shifting, are being installed

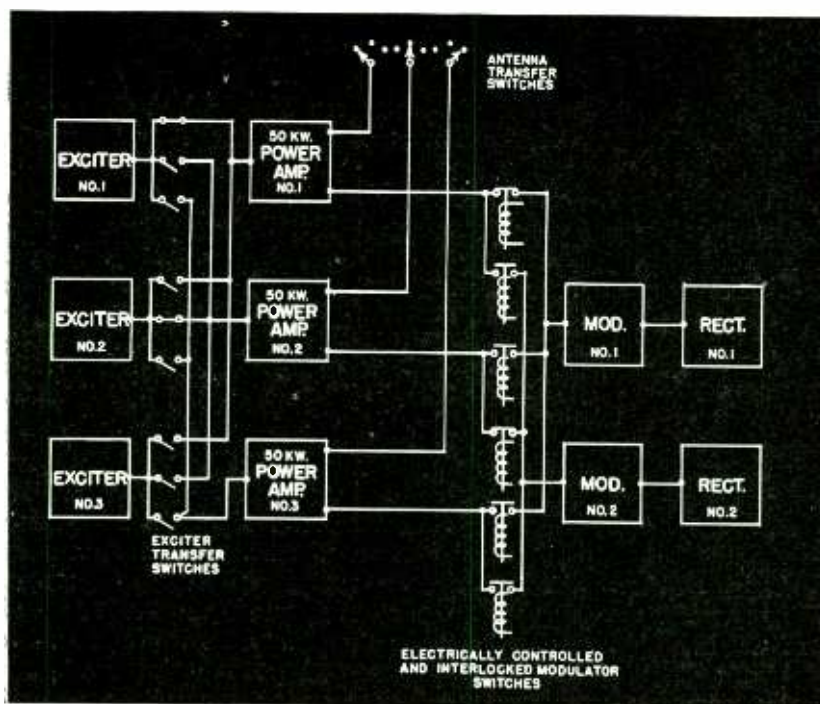

Fig. 1—Block diagram of the power amplifier, modulator, selector system. Three power amplifiers will be used so that two may be in use while the third can be changed over to a new frequency. The switchover is then instantaneous

By  
A. B. CHAMBERLAIN  
Columbia Broadcasting System



Fig. 2—Azimuth chart of the world centered on New York. The same antenna (with radiator and reflector interchanged) may be used for transmission to London or Mexico City

**A**T the present time the Columbia Broadcasting System is constructing two new 50-kw international broadcast stations near Brentwood, Long Island, a sparsely populated location approximately 40 miles east of the New York studios. Completion of this project is scheduled for September 1941.

### The Brentwood Installation

Through special arrangements with the Mackay Radio and Telegraph Company, the site of their Brentwood, Long Island transmitting plant will be used, where there are now 22 medium and high powered radio telegraph transmitters. Mackay is now using thirty directive antenna arrays on their 1200-acre site which, from the standpoint of

topography, accessibility, and availability of public utility services, is excellent for short-wave transmission. It is removed from populous centers, airports, and airways. A fireproof, single story wing, 40 feet by 60 feet, with basement, is being added to the existing Mackay transmitter building.

Primary power is available from two different sources over alternate routes to the CBS-Mackay sub-station, from which three underground 2300-volt cables run to the transmitter building, a distance of 0.66 mile. The three power feeders have a combined capacity of 1800 kva.

Audio, measuring, and monitoring facilities are being designed by Columbia's engineering staff. Compression of volume range, modulation peak-chopping, high-frequency

pre-emphasis, and variable low- and high-pass filters will be employed for optimum results. Because of the nature of the service, the frequency- and modulation-monitoring apparatus arrangement is more complex than that usually found at standard broadcast stations.

### Transmitters

Two 50-kw transmitters are being manufactured for this installation by the Federal Telegraph Company, to CBS specifications. Each transmitter will be capable of full power output to the transmission line, at 100 percent modulation, over the entire frequency range of 6 to 22 Mc.

One of the major requirements of this service is the ability to shift



instantaneously from one operating frequency to another in a simple, positive and reliable manner. There are several ways to do this<sup>1</sup> and CBS engineers chose the method described after careful consideration of the factors involved. Three complete r-f from crystal oscillator unit to 50-kw power amplifier are provided. This arrangement allows the operators to pre-set the operating frequency of one r-f section while the other two r-f sections are being operated simultaneously.

Each transmitter will be capable of operating on any one of a total of twelve frequencies. Initially, nine crystals will be provided for the frequency control of each r-f section, a total of twenty-seven crystals being required for the specific frequencies assigned to WCBX and WCRC—6060, 6120, 6170, 9650, 11830, 15270, 17830, 21520, and 21570 kc.

Actually, the apparatus for these two stations will consist of two and one-half transmitters. All of the radio frequency equipment with associated power supply and control facilities will be provided in triplicate, and the high-level Class AB

modulators and high voltage power supplies in duplicate. Thus, the two stations may be expanded by the addition of a third modulation and power supply unit which will provide a third complete 50-kw transmitter. Equipment will be installed to accommodate this probable future expansion.

The entire equipment is a-c operated, utilizing specially designed water-cooled tubes, automatically regulated power supplies, and with all circuits fully protected automatically. The apparatus is arranged so that complete accessibility to the interior of the transmitter units is provided for ease of maintenance, but the operating personnel is safeguarded in every respect.

Performance characteristics will be in accordance with the specifications in Table I which conform in every respect with the standards of good engineering practice promulgated by the Federal Communications Commission.

Circuits are conventional in design for the most part. There are a few noteworthy departures, including the line-type tank circuit ar-

**TABLE I**  
**Transmitter Performance Specifications**

<b>Carrier Frequency Range</b>	<b>6-22 Mc</b>
<b>Carrier Power, 6-22 Mc</b>	<b>50 kw</b>
<b>Modulation Capability</b>	<b>100%</b>
<b>Audio Frequency Response (1000 cps reference)</b>	<b>40-10,000 cps ± 0.5 db</b>
<b>Total Harmonic A-F Distortion, r-m-s (100% Modulation) (40-7500 cps)</b>	<b>Less than 5%</b>
<b>Unweighted Carrier Noise Level, r-m-s total (100% modulation reference)</b>	
<b>100-5,000 cps</b>	<b>-60 db</b>
<b>Below 100 and above 5,000 cps</b>	<b>-50 db</b>
<b>Carrier Shift 0-100% Modulation</b>	<b>Less than 3%</b>
<b>Carrier Frequency Stability</b>	<b>Within ± 0.0025%</b>

angement of the power amplifiers, the method of matching the power amplifier outputs to the transmission lines, and the arrangement for multi-frequency operation.

Voltage regulators, power transformers, modulation transformers, reactors, and other associated equipment, will be located in a basement directly beneath the apparatus with which they are associated. The line type 50-kw tank and line matching apparatus will also be located in the basement and tuning adjustments of the three power amplifier output circuits will be made by remote control.

#### Transmission Lines

One of the major considerations is the switching facilities to be used for interconnecting any of the three 50-kw amplifier output line buses with any desired combination of the 13 transmission lines. Thirty-nine switches, specially designed for this purpose and manually operated, will be interlocked mechanically and electrically, to insure proper operation and protection to apparatus. As the voltage on the lines will be high during peaks of modulation (14,000 volts rms) special insulators with proper fittings must be used. This is also true of the transmission line and antenna insulators, all of which will be designed for operation at 400 kw peak power at 22 Mc with a liberal safety factor. These switches are arranged so as not to unbalance the impedance of the lines, and thus reduce to a minimum load-

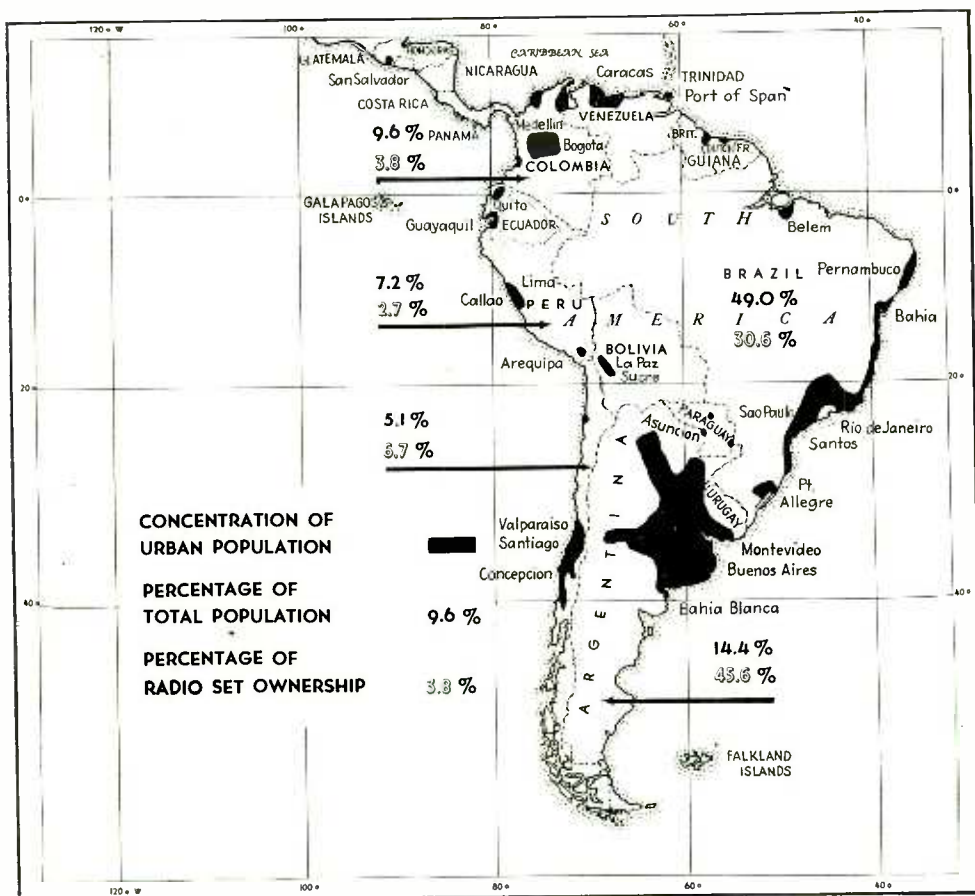

Fig. 3—Map of Central and South America showing distribution of population and radio receivers

ing difficulties, reflection losses, and undesired radiation.<sup>2</sup>

More than 100,000 feet of copper wire will be used for the open two-wire balanced transmission lines. Each of the lines will have a characteristic impedance of about 550 ohms. It is interesting to note that 20 tons of No. 0 B&S gauge copper wire will be required for the construction of transmission lines and antenna elements.

Special networks will be installed on the transmission lines for the purpose of performing a variety of services including the matching of impedances, the control of phase relationships, the division of power, filter action, the filtering of harmonic frequencies, and the simultaneous transmission of two frequencies over one transmission line.

Some of the functions of these networks could be carried out using lumped inductance and capacity, but it has been found more practical to utilize networks made of sections of transmission line of the same construction as the feeders themselves. The latter type are preferable mechanically and economically because their performance may be calculated with greater accuracy. Their electrical properties depend on linear dimensions which may be measured on the job more simply and more accurately than inductance or capacity could be measured under similar circumstances. Some of the networks that will be used are the re-entrant type, which consists of two sections of transmission line joined at their

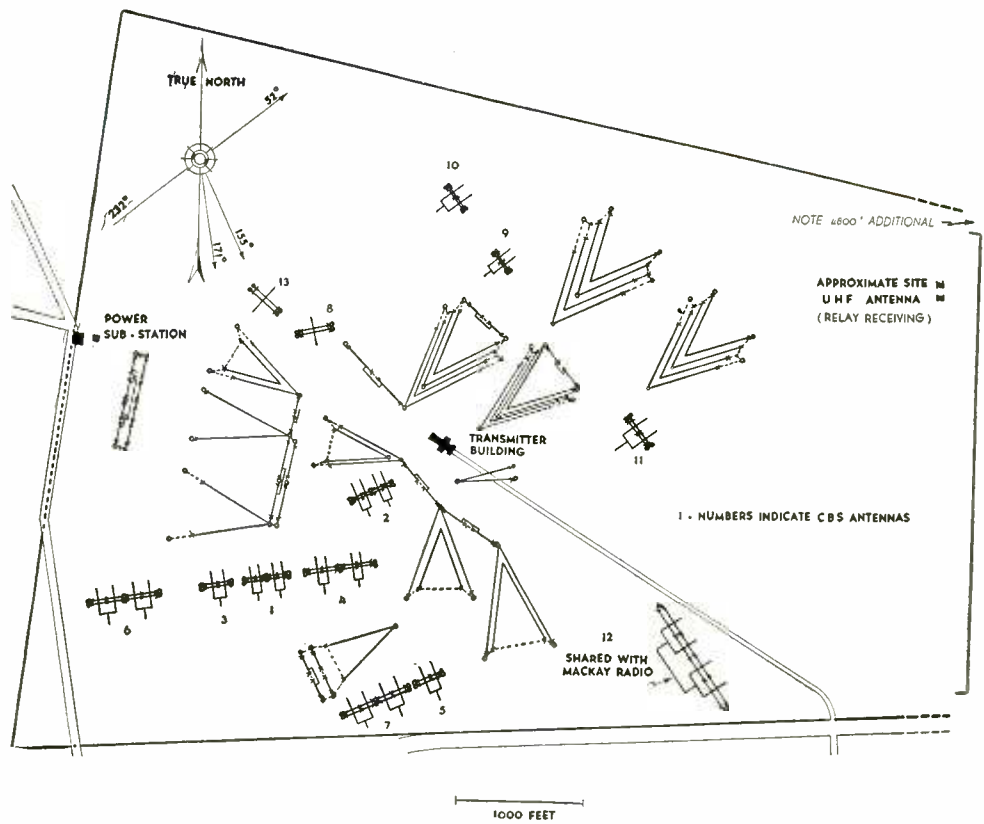

Fig. 4—Layout of antennas at the transmitter site. The numbered antennas are those of CBS and antenna 12 is shared by CBS and Mackay. Antennas 9, 10, and 11 can be used for either England or Mexico and Central America by reversing the direction of transmission

ends in such a way as to form a closed loop.<sup>3</sup>

One of the antennas for transmission to Europe will be used simultaneously by CBS and Mackay, the former using a modulated 50-kw 6120 kc carrier and the latter a 50-kw 6935 kc cw carrier.

A re-entrant two-stage conjugate filter will be used to isolate the two transmitter output circuits and to maintain proper impedance relation-

ships between the power amplifier outputs and the line feeding the antenna array.<sup>3,4</sup> A network of this type consists of four filters. Two on one side of the network are designed to block 6935 kc. The other two filters on the opposite side of the network block 6170 kc. The first two filters are conjugate at 6170 kc while the other two are conjugate at a frequency of 6935 kc.

These networks will be installed

Fig. 5—Diagram of a typical 4-section horizontal broadside array designed for operation on frequencies of 9650 and 11830 kc. It has gains of 15 and 16 db for 9650 and 11830 kc respectively

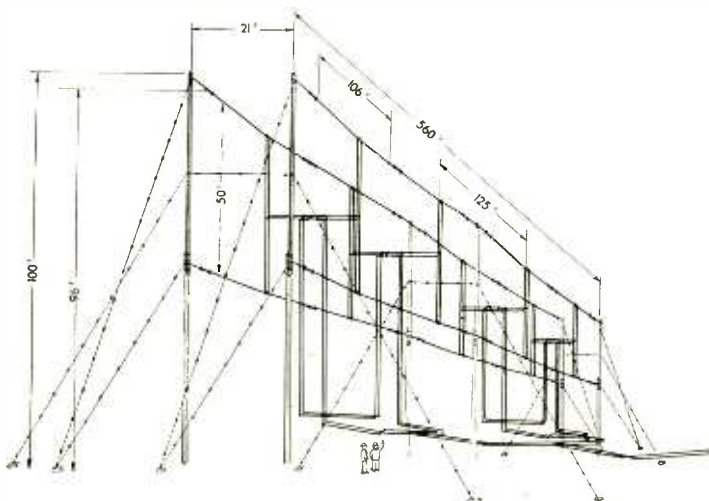
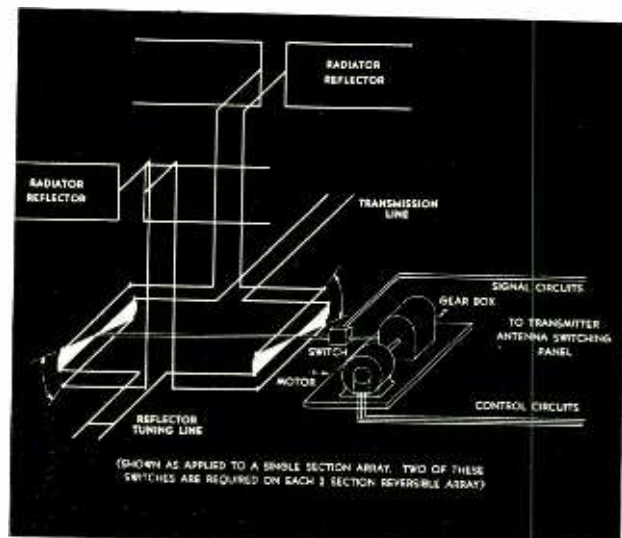

Fig. 6—Switching system for reversing the direction of transmission of antennas 9, 10, and 11. Two of these switches are required on each 2-section reversible array





W 6db down 200Kc

4 pair optimum coupled coils

10.7 Mc  $f_0$

$$Q = W \frac{f_0}{f_w} = 1.13 \times \frac{10.7}{.2} = 1.13 \times 53.5 =$$

$$Q = 60.5$$

W 40db down

$$f_w = 3.5 \times \frac{10700}{60.5} = 3.5 \times 177 = 620 \text{ Kc}$$

10.7

log 2 = .30103

$$\Delta f = \frac{f_0 \sqrt{2}}{Q} \sqrt{\left(\frac{E_w}{E_c}\right)^{\frac{2}{n}} - 1}$$

4 | .30103  
 .07526

antilog .07526 = 1.189

$$Q = \frac{10.7 \times 1.414}{0.2} \sqrt{\left(2^{\frac{2}{8}} - 1\right)} = 0.189$$

$$= \frac{10.7 \times 1.414}{0.2} \times .43$$

$$= 32.5$$

10.7  
 7.07  
 749  
 7490  
 75649

75.6  
 .43  
 2268  
 3024  
 32508

$$W = \left(A^{\frac{2}{n}} - 1\right)^{\frac{1}{2}}$$

$$W = \frac{f_w Q}{f_0}$$

$$\frac{f_w Q}{f_0} = \left[\left(\frac{E_0}{E_w}\right)^{\frac{2}{n}} - 1\right]^{\frac{1}{2}}$$

$$Q = \frac{10.7}{.2} \left(2^{\frac{1}{4}} - 1\right)^{\frac{1}{2}} = \frac{10.7}{.2} (.19)^{\frac{1}{2}} = \frac{10.7}{.2}$$

$$\frac{f_w Q}{f_0} = \sqrt{2} \left[\left(\frac{E_0}{E_w}\right)^{\frac{4}{n}} - 1\right]^{\frac{1}{4}}$$

log .414 = .617

4 | -.383  
 -.096

$$Q = \frac{10.7 \times 1.414}{.2} \times (.414)^{\frac{1}{4}} =$$

antilog .904 = .802

$$= \frac{10.7 \times 1.414 \times .802}{.2} = 60.7$$



Directional Antennas to South America and West Indies						
Ant. No. †	Freq. Kc	Direction True	Beam Width (6 db down)	Vert. Angle (Max. Rad.)	Gain † DB	General Direction
1	17830 21520 21570	171°*	14°	14°	15	Argentine—W. Coast
2	Same	155°*	Same	Same	Same	Brazil—E. Coast So. America
3	11830 15270	171°*	30 22	18 14	11.5 13	Argentina—W. Coast So. America
4	15270 17830	171°*	14 12	17 14	15 16	Argentina—W. Coast So. America
5	11830 15270	155°*	30 22	18 14	11.5 13	Brazil—E. Coast So. America
6	9650 11830	171°*	14 12	18 16	15 16	Argentina—W. Coast So. America
7	9650 11830	155°*	14 12	18 16	15 16	Brazil—E. Coast So. America
8	6060 6120 6170	166	41	18	10	So. America

Directional Antennas to Europe or Mexico and Central America						
9	17830 21520 21570	52°* or 232°*	28 24	14 12	12.5 13	England or Mexico and Central America
10	11830	52°* or 232°*	30 22	18 14	11.5 13	England or Mexico and Central America
11	9650	52°* or 232°*	28 22	18 15	12 13	England or Mexico and Central America
12	6060 6120 6170	54	14	18	15	Central Europe (Shared with Mackay Radio)
13	Same	220	41	18	10	Mexico and Central America

\*Adjustable ± 10 degrees. †Front to back ratio 18 to 26 db  
‡30 antenna array—frequency combinations

near the transmitter building so that only a single long transmission line will be required to carry the two frequencies to the antenna. This feeder is about 3800 feet long. The economic advantages are obvious as this plan eliminates the requirement

of two separate long transmission lines and two separate antenna arrays. Several of these networks have been successfully used by Mackay at Brentwood. Their use has been entirely trouble-free and excellent constancy of adjustment has been

obtained with a minimum of maintenance attention. Experience has shown that a 5 per cent separation between frequencies of two transmitters is sufficient for satisfactory operation of these networks. The degree of filtering obtainable under these conditions is such that the attenuation of the undesired frequency amounts to about 40 to 50 db. The power loss is not more than 0.2 to 0.3 db.

*Directive Antenna Arrays*

An azimuth chart centered on New York City (Fig. 2) indicates the true bearings to the various world-wide areas it is proposed to serve. The concentration of urban population and receiving sets in South America are shown in Fig. 3. The direction and distribution of population and other factors, resulted in the initial decision to build thirteen unidirectional arrays, giving thirty antenna array-frequency combinations.

The Brentwood antennas will consist of stacked horizontal broadside arrays, with parasitically excited reflectors.<sup>5</sup> They comprise rows of 2, 4, or 8 elements from 0.50 to 0.64 wavelength long placed side by side in two rows stacked one above the other, with a vertical separation between rows of 0.50 to 0.64 of a wavelength. The reflector is separated from the radiator by 0.20 to 0.24 wavelength. The height above ground of the bottom row of elements depends upon the frequency for

(Continued on page 70)

Figs. 7 and 8—Antenna transmission lobes for two programs to South America (east and west coasts) and lobes for

simultaneous transmission to Europe (or Mexico) and Argentina. The dotted lobes indicate the transmission to Mexico

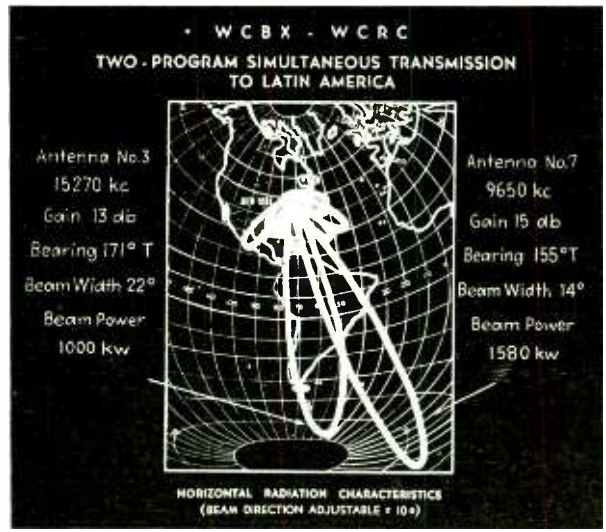

# HYPEx HORNS

**T**HE radiation of sound is ordinarily accomplished by the action of a vibrating surface in a transmitting medium. In the usual direct radiator loud speaker this surface is the diaphragm, actuated by the driving unit or motor. The mechanical impedance of such a structure is necessarily high because of the relatively large motor and diaphragm mass. This cannot be avoided if a stable moving system and piston-like motion of the diaphragm over a substantial frequency range are to be achieved. In addition, if the motor is efficient it is tightly coupled to the electrical source and this further increases the effective mechanical impedance at most frequencies.

The condition for maximum power transfer between diaphragm and medium requires that the impedance looking from the diaphragm into the medium be the conjugate of that seen looking back into the diaphragm. By conjugate is meant that the resistive components are equal, and that the reactances are equal in magnitude but opposite in sign as indicated in Fig. 1. Thus, the circuit effectively consists of two resistors in series since the net reactance is zero. In direct radiator speakers this ideal condition is approached only at resonance, for the moving system impedance is normally very much higher than that of the air load. Therefore direct radiator loud speakers are essentially low efficiency devices because of impedance mismatch.

Much better efficiency could be obtained if the radiating surface were increased in area but not in mass. This is impossible in cone loud speakers since the mass must be increased as the area is increased to maintain adequate rigidity. However, by the addition of a suitable horn, the desired effect is obtained since the large mouth becomes a virtual source which, because of its size, has desirable impedance and radiation characteristics.

An ideal horn would transform the low acoustical impedance (seen by the virtual source looking into the medium) into the relatively high impedance of proper magnitude and angle required to load the diaphragm ideally. The required ideal impedance transformation can be readily obtained with simple acoustical elements at a single frequency. The

difficulty comes in finding elements which give this condition over a considerable range of frequencies. This complication occurs because both the impedance looking into the diaphragm and the impedance looking out of the mouth of the horn vary both in magnitude and angle by a large factor over the useful frequency range. The ideal horn can be specified only when the impedances between which it is to work are known.

In most cases the load impedance of the horn seen looking out of the mouth may be approximated by the impedance of a constant mass (inductance) and resistance in parallel as shown in Fig. 2. The ideal horn may be more closely realized if the mouth impedance is constant and mostly resistive over the useful frequency range. In practical cases this

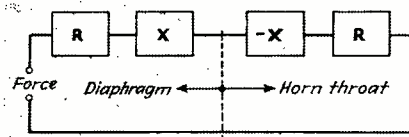

Fig. 1—Conjugate impedance matching in horn loud speakers

is attained if the wavelength of the lowest frequency to be reproduced is not more than three times the mouth diameter. An equivalent statement is that the product of this lowest frequency and mouth diameter (in inches) should be greater than 4000.

The impedance seen by the horn looking back into the driving unit is much more complicated. However, in most horn loudspeakers the overall high-frequency behaviour is practically independent of the particular horn flare used. Hence, it is in the low frequency region that the type of horn is most important, and Fig. 2 shows a satisfactory approximation to the circuit for the driving unit below its unloaded resonant frequency. Thus the horn, in the range of greatest interest, has to work from a series  $RC$  circuit into a parallel  $RL$  circuit. Because of the variety of conditions possible even with these greatly simplified source and load impedances it is seen that a horn offering a single type of impedance characteristic will be useful only in restricted cases. The ideal

horn must then have impedance characteristics adjustable over a considerable range.

The nature of the horn throat resistance required may be arrived at by considering the load out of which it is operated at low frequencies. The effective value of the electrical source, voice coil and diaphragm resistances are approximately constant. Ideally therefore the throat resistance of the horn should be constant and equal to the combined value of these three as seen from the diaphragm. Since no horn is known which has a constant throat resistance down to zero frequency, horn research has been directed for many years toward approximating this ideal. In 1919, after investigating many horn shapes, which had been evolved experimentally, Webster reported that the most of them fell into three groups, one of which was the type now known as the exponential. His evaluation of the throat impedance showed that the exponential horn had a throat resistance-frequency characteristic which, above a certain critical or cut-off frequency, rose to its ultimate high frequency value more rapidly than any other horn then known. Subsequent analysis of other types of horns revealed none superior to the exponential in this respect.

However, a recent investigation of generalized plane wave infinite horn theory has led to the development of a family of horns in which the resistance may be made to rise much more rapidly from the cut-off frequency than in the exponential. To this family the name "Hypex" has been given. By the choice of a single parameter  $T$  the throat resistance may be made to rise to any given amount above the ultimate value, to which it then falls. In Fig. 3 are shown curves comparing the exponential with two members of the Hypex family by means of the throat resistance expressed in per



Long considered the most desirable taper, the exponential horn now gives way to a new family of horns of improved throat resistance characteristics which may rise at frequencies near cut-off. Improved low-frequency output is obtained with Hypex horns

By VINCENT SALMON, *Jensen Radio Mfg. Co., Chicago, Ill.*

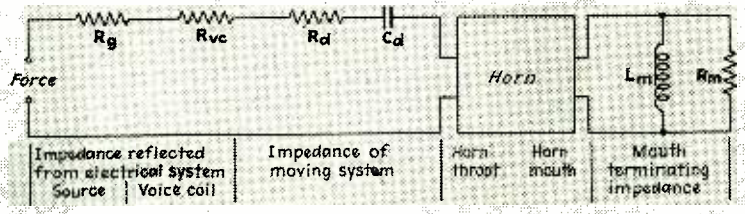

Fig. 2—Equivalent mechanical circuit of the loud speaker; accurate at low frequencies

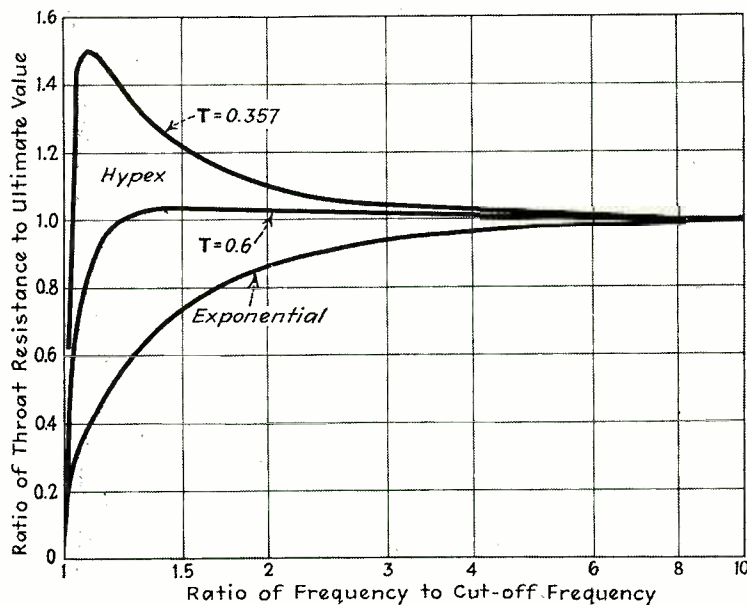

Fig. 3—Comparison of throat resistance of infinite exponential horn and Hypex horns for two values of the parameter T

cent of the ultimate value, which is the same for all. When the driving unit is operating at constant diaphragm velocity these curves also indicate the relative acoustic output. Resistance characteristics other than those shown are readily available for special cases. For example, the resistance may be made to rise approximately proportional to a selected small power of the frequency over a considerable range with a Hypex horn. On the other hand, lack of constancy in the mouth re-

sistance may partially be compensated by the use of a Hypex horn having the appropriate throat resistance rise near cut-off.

While resistance considerations will generally dictate the particular Hypex horn to be used, the reactance characteristic may be a controlling factor. In Fig. 2 the frequency region is that below the unloaded resonance of the driving unit where the reactance of the moving system is capacitive and therefore negative. Now if the cut-off frequency of

a suitable Hypex horn is placed below this resonance frequency, the horn throat reactance will be positive, but will increase with decreasing frequency. Thus, it is possible to make the net mechanical reactance close to zero between unloaded motor resonance and horn cut-off frequencies. With the proper resistance characteristic this reactance annulling makes the system approach a conjugate match of impedances with consequently improved efficiency of power transfer as outlined in the first part of this discussion. In Hypex horns the reactance may be chosen to fit more complicated driver units than are suggested by Fig. 2, thus adding greatly to the flexibility of design of horn loud speakers.

The impedance characteristic of an infinite exponential horn is that of a simple high-pass constant-k filter shunted by a constant mass (inductance). The input resistance of the combination deviates from a constant value over too large a portion of the frequency region near cut-off to permit good matching to a constant resistance source. In electric wave filters this difficulty is largely met by the "m-derived" filter developed by Zobel. In Hypex horns the resistance characteristics are analogously adjustable, thus allowing the acoustic realization of the many advantages of the "m-derived" type.

The Hypex family of horns may be made in any form such as straight, coiled, folded or re-entrant, or may have any cross section such as circular, rectangular, etc. Their field of application includes that of present types, but because of the adjustability of throat impedance better low frequency response and more satisfactory reactance annulling are possible. In addition, Hypex horns may be used as receivers in sound ranging devices, as terminating sections for acoustic lines, or in any other application where flexibility of design cannot be obtained from present types of horns.

# Measurements in F-M Transmitters—II

In the second half of his paper on f-m measurements, Mr. Thomas discusses methods of determining the linearity and degree of modulation, determination of transmitter power, arrangements for measuring the mean carrier frequency, and concludes with practical considerations of the problem of making field strength surveys

By H. P. THOMAS

*General Electric Company  
Schenectady, N. Y.*

**I**N order to reproduce sounds faithfully the output of the receiver should bear a direct relationship to the input to the transmitter. In other words there should be no compression or expansion of the volume range of the original sounds. Since no expansion system is normally employed in receivers, this means that the transmitter frequency swing should be directly proportional to the audio input. This is easily measured by reading the audio output from a modulation monitor as the audio input to the transmitter is varied in amplitude.

Measurement of the carrier frequency of an f-m transmitter can be done very simply when there is no modulation, using the usual methods employed with a-m transmitters. A satisfactory method is to beat the carrier frequency against that of a crystal oscillator and measure the audio beat frequency. However, with such methods, the frequency can be checked only very occasionally when a transmitter carries a broadcast program. There are two methods by which the carrier frequency can be measured at any time regardless of modulation. One consists of dividing the frequency a sufficient number of times to reduce the frequency deviation to such a small amount that there is a steady carrier which can be measured by the usual methods.

The other method is to impress the

f-m signal on a linear-slope circuit such as that used for a modulation monitor. The average direct voltage developed by this circuit is proportional to the mean carrier frequency. When this system is used as a frequency monitor, a crystal oscillator can be provided to check the alignment of the circuit. A complete monitoring system for an f-m transmitter may consist of a discriminator circuit operated from a converter and crystal oscillator, with another crystal oscillator provided for checking the alignment of the circuit. A d-c instrument can be connected to the output of the discriminator and may be calibrated directly in terms of frequency deviation from the assigned carrier frequency. Audio output which can be used directly to operate any type of modulation indicator is also available, and through

a de-emphasis circuit to operate an audio amplifier and loudspeaker. Good amplitude limiting should be provided in such an instrument in order to make the readings independent of any normal variation of applied signal level, and also to prevent any small amount of amplitude modulation of the signal from affecting the instrument.

An f-m transmitter should radiate a signal of constant amplitude at all times, but in practice it is difficult to prevent some unwanted amplitude modulation. A small amount of amplitude modulation will not injure the operation of the system if there is a sufficiently good limiter in the receiver. However, if a receiver is located in a fairly weak signal area, it probably will not give more than 15 to 20 db of limiting action, and to be on the safe side we should not

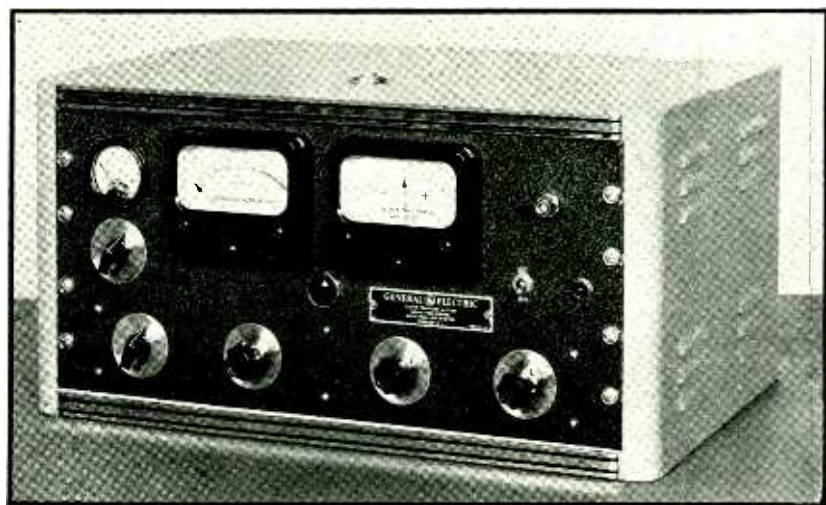

**Fig. 1—Monitor for frequency-modulation radio station. This unit measures the center-frequency deviation with or without modulation as well as the percentage modulation. It contains a modulation limiter flasher, high fidelity audio frequency output, and temperature controlled piezoelectric crystal**



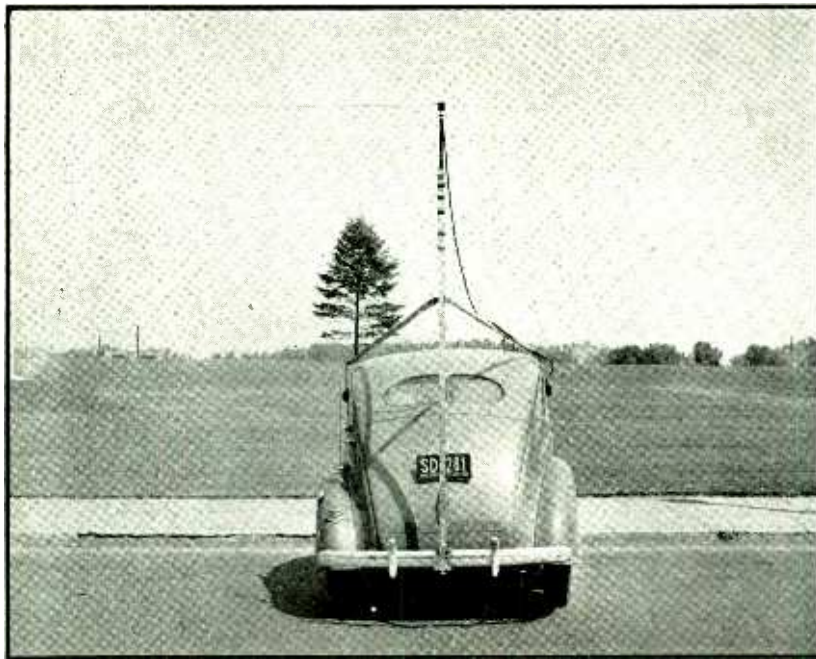

Fig. 2—Automobile equipped with horizontal dipole antenna for field-intensity surveys. This equipment was used in making actual surveys of frequency-modulation station W2XOY

count on more than about 10 db. Now let us consider what effect some amplitude modulation of the transmitter will have on a receiver with an imperfect limiter. First assume that the transmitter is amplitude modulated as well as frequency modulated by the audio signal. Any variations of amplitude which pass through the limiter of the receiver will effectively change the slope of the discriminator curve during the modulation cycle, or in other words will cause distortion. Next consider the effect of a little a-m noise such as might result from ripple voltage variations of the plate supply in the last stage of the transmitter. Even though the limiter in the receiver is not perfect, this noise can be eliminated by a balanced detector such as is commonly used in f-m receivers by tuning so that the signal is exactly at the balance point. However, since the average listener will not tune a receiver very carefully, and since this balance condition does not hold during modulation, noise is present during modulation, although it is balanced out so that the signal is quiet during times of low or zero modulation. Therefore, it seems advisable to set some limit to the amount of amplitude modulation permissible in an f-m transmitter. Measurement of amplitude modulation is done by the usual methods; a linear a-m detector is coupled to

the output of the transmitter and a reading of the direct voltage developed across the load is used as a measure of the carrier strength. Any alternating voltage developed in the absence of modulation is classed as noise; any alternating voltage developed due to the modulation results from an amplitude modulated signal. The magnitude of these modulations should be expressed in terms of 100 percent amplitude modulation. In other words if the voltage developed by the carrier is  $E_c$  and the r-m-s modulation voltage is  $E_m$ , the modulation factor will be  $\sqrt{2E_m/E_c}$ .

#### Power Measurements

Since f-m transmitters operate at the quite high frequencies of 40 to 50 Mc (and perhaps as high as 300 or 350 Mc for relay transmitters) the accurate determination of the power output presents some problems. Probably the simplest method to use for low-power transmitters, i. e., up to about 1 kw is to use incandescent lamps as a dummy load and arrange a phototube to measure the brightness of the lamp. The lamp can be calibrated by lighting it with ordinary 60-cycle power from a variable voltage source, and measuring the power with a wattmeter. Any differences in impedance or resistance of the filament at the high frequency due to skin effect will not appreciably affect the results since the bright-

ness of the lamp depends only on the actual power in the filament. However, if the filament is not all lit to the same brightness, there may be a considerable error, for the intensity of illumination is not a linear function of power.

An uneven brightness of the two ends of the filament or bright spots are sometimes observed, and have often been ascribed to standing waves on the filament. However, I do not think this is due to the length of the filament, since even at quite high frequencies the actual filament is a fairly small part of a wavelength. I believe that in most cases such effects are caused by large potentials from the lamp to ground which may cause heavy capacity currents to flow in portions of the filament, thus causing irregular heating. Usually, by proper tuning of the load circuit and choosing a lamp of suitable impedance, it is possible to reduce the potentials so that uniform heating is obtained. Of course, in order to be able to observe the filament and thus be sure it is uniformly heated, the lamp should have a clear glass bulb.

There may be some error caused by losses in the glass seal and the lead wires at high frequency which are not present when the lamp is calibrated at low frequency. In order to reduce this type of loss as much as possible it is advisable to remove the base of the lamp. The lead and seal losses are probably not very large, for any large amount of power dissipated at that point would prob-



Fig. 3—View of the equipment used in field-intensity surveys of W2XOY. Note the automatic recorder

ably destroy the bulb, and of course losses of this type are in a direction such as to make the power measurements on the conservative side.

At power levels greater than 1 or 2 kw it will be found that lamps of sufficient size to handle the power have so much inductance in the leads that very high voltages are developed across the terminals at high frequency and arcs may occur between the leads or across portions of the filament, so some other method of measurement is required. If we can load the transmitter into an impedance of known value and measure the current, we can calculate the power. A correctly terminated transmission line presents an impedance which is pure resistance at high frequency and has a value equal to its surge impedance. Thus, we can terminate a transmission line with an antenna, measure the voltage along the line by means of a vacuum tube voltmeter and adjust the termination until all the standing waves on the line are eliminated. The line is then terminated in its surge impedance, and we can measure the current into the line and calculate the power from the relation  $P=I^2Z$ . The ammeter used for the current measurement should be accurate at the frequency being used. Many r-f ammeters are not accurate at the higher frequencies, particularly in the large current sizes which will be required for measurements of the higher power.

This method of measurement is not quite as simple as it sounds, since the accurate termination of a transmission line is a laborious procedure. Care should also be taken to be sure that the current measured is that actually entering the line and does not include any capacity current from the meter case to ground or other stray currents. Power can also be computed from the relation  $P=E^2/Z$ , by making voltage measurements with a diode or multi-element tube. This method eliminates troubles of stray capacity. In large transmitters employing water-cooled tubes it is possible to make a fairly accurate determination of the power output by a measurement of the power loss, in the tubes and subtracting that from the total power input including d-c power input in plate plus filament and grid power. The loss is measured by reading the temperature difference between the inlet and outlet

water and measuring the rate of flow. The power in kilowatts absorbed by the water is then given by  $P=0.263 T q$  where  $T$  is the difference in temperature between inlet and outlet water in degrees C.,  $q$  is the rate of flow of water in gallons per min. The plate tank circuit losses should also be subtracted from the input. If the tank is built so that the cooling water for the tubes also flows through the inductance, as is often done in high-frequency transmitters, this loss will also be included in the measured water loss. Otherwise some estimate of the loss must be made from a measurement of the  $Q$  of the circuit and the estimated voltage across it. For Class C operation

ter into some form of dissipative load which is water cooled. Then the power delivered to the load can be measured by noting the temperature rise in the water and the rate of flow as described in measuring plate loss in water-cooled tubes. The dissipative load may be a high-loss transmission line made with high resistance conductors or else a poor dielectric.

#### F-M Receivers

One of the chief features of an f-m receiver is the limiter. In order to determine how well the limiter is operating, an a-m signal should be applied to the receiver and the amount of amplitude modulation

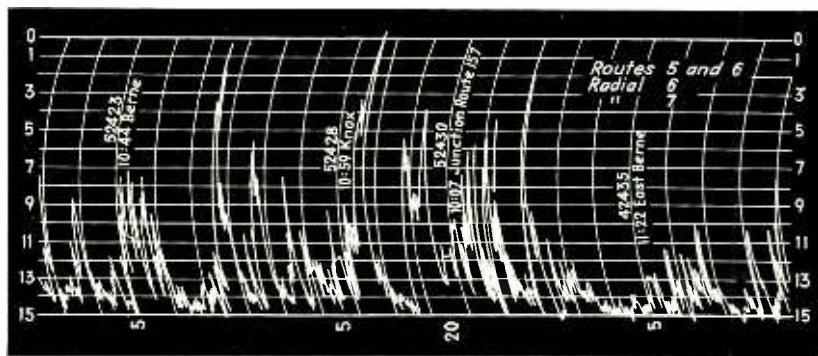

Fig. 4—Section of typical record of field intensity for radio station W2XOY, operated at 2.5 kw. The car routes and radials for which this record applies are shown in the map

with efficiencies in the order of 50 to 60 per cent the r-m-s value of the r-f plate voltage can be assumed to be about 50 per cent of the direct component of the plate voltage. Even if this assumption is not very accurate it will not affect the measured power output very seriously since the tank loss will normally be fairly small. The power supplied to the grid of the tube will be the grid driving power, which is given very closely by the product of the peak r-f grid voltage and the d-c component of grid current, minus the power in watts in the bias supply. The r-f grid voltage can be measured, but it is usually sufficiently accurate to estimate, by an examination of the tube characteristics, the peak positive grid swing required to drive the tube to the value of plate current being used. As in the case of the tank loss, this is a fairly small correction, and great accuracy is not necessary.

Another method of measuring power which is suitable for high power levels is to load the transmit-

ter into some form of dissipative load which is water cooled. Then the power delivered to the load can be measured by noting the temperature rise in the water and the rate of flow as described in measuring plate loss in water-cooled tubes. The dissipative load may be a high-loss transmission line made with high resistance conductors or else a poor dielectric.

obtained at the output of the limiter measured. A curve can then be plotted showing the amount of limiting as a function of signal input to the receiver. If the receiver selectivity is measured by the methods usually employed for a-m receivers, that is, by determining the amount of signal required at frequencies off resonance to produce standard output, a true picture of how the receiver operates will not be obtained. This is because a strong f-m signal will demodulate a weaker signal and thus reduce the interference ratio to obtain a signal-to-noise ratio of the receiver for a specified output. Another factor which is important in the operation of a receiver is the signal-to-noise ratio obtained at the output. If there is enough signal to suppress the shot noise of the tube, this noise will consist almost entirely of power supply ripple. Part of this ripple may be introduced directly in the audio amplifier, a more serious source of trouble is likely to be the hum introduced in plate or filament voltages by frequency modulation



of the oscillator. To measure this hum it is necessary to measure the noise output when the receiver is tuned to a very stable signal source such as a battery operated oscillator or a good crystal oscillator. This measurement is the same as that described for a modulation monitor. Hum introduced by frequency modulation of the oscillator in a receiver is particularly difficult to overcome in very high-frequency receivers such as might be used for relay purposes. This can readily be appreciated when it is realized that to have a noise level of  $-70$  db the oscillator must not vary more than 25 cps. If the oscillator is operating at 300 Mc this represents a precision of about 1

be made. These radials must then be analyzed by dividing them into sectors of not more than 10 percent of the service radius nor more than 5 miles, and the median field determined in each sector. A field strength of 1000 microvolts for urban areas and 50 microvolts for rural areas is considered necessary for satisfactory service. The field survey may have to be extended to the 5 microvolt line in connection with interference problems.

The equipment required for these measurements consists of an antenna, receiver, and recording meter which can be calibrated in terms of field strength. A commercial type of equipment of this sort is avail-

in some way, such as by reading limiter grid current. In this case, the receiver will have to be calibrated. However, the antenna must be calibrated from a known field.

A standard field for this purpose is usually set up by using an oscillator feeding a small loop in which the current can be measured, and calculating the field at a distance. To remove the effect of the ground, the antenna to be measured and the loop can be suspended above ground at a height which is fairly large compared to the separation between them. The antenna is usually mounted above a car at a height of about 10 feet above ground. The effect of the car on the antenna calibration must be determined. This can be done easily by measuring the field from the transmitter with the antenna set up in a level, open space free of reflected signals and then taking another reading at the same spot with the antenna mounted on the car. Readings should be repeated with the car facing in several different directions. Usually the correction factor for the car will be found to be quite small. Readings taken with an antenna height of 10 feet will have to be multiplied by 3 as the field strength desired is based on a 30 foot antenna height.

A map showing the location of the 1000 and 50 microvolt contours of W2XOY operated at a power level of 2.5 kw is shown in Fig. 5. This is only a preliminary survey, and is used merely as an example of the results which will be obtained. It does not show a typical case for several reasons. First of all the transmitter is located on the edge of a high escarpment running roughly northwest to southeast, so there is a large effective height of approximately 1200 feet in the northeast direction, but very little effective height in the opposite direction. The result can be seen on the map; there is a very much greater range in some directions than in others. In the case of this station, the large signal is in the direction of the desired service area, i.e., Albany, Schenectady, and Troy. Also, at the time these measurements were taken the antenna being used was a single bay turnstile which has a field gain of  $-3$  db compared to a simple vertical dipole, whereas an antenna is now being installed having a gain of  $+4$  db.

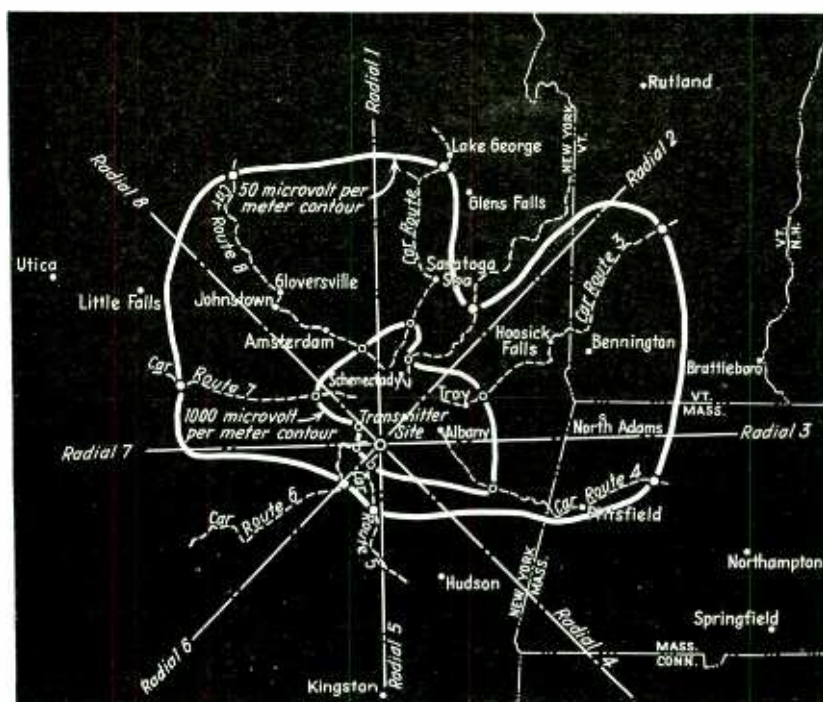

Fig. 5—Measured field intensity contours for radio station W2XOY, operated on 2.5 kw and using a single-bay turnstile antenna. The contours shown here are to be regarded as a preliminary survey rather than as a typical or final example of the operation of W2XOY

part in 100 million. Other characteristics of a frequency modulated receiver, such as frequency characteristic, distortion, etc. can be measured by the usual methods if an f-m signal generator having sufficiently good characteristics is available.

#### Field Intensity

The F.C.C. regulations require that, within one year after an f-m station has begun regular operation, a field survey shall be made to determine the actual boundaries of the service area. Continuous records of the field strength along at least eight radials from the transmitter shall

able which is calibrated with its own dipole antenna, and has suitable attenuators to cover a wide range of signal strength. It has a power supply for operation from a 6-volt battery which has a voltage regulator so that the readings will be independent of the condition of the battery within fairly large limits. There is only one objection to this apparatus, and that is that the intermediate frequency of the receiver is so sharp that readings cannot be taken while the transmitter is fully modulated. It is possible to use any good f-m receiver for such measurements if a suitable meter can be connected



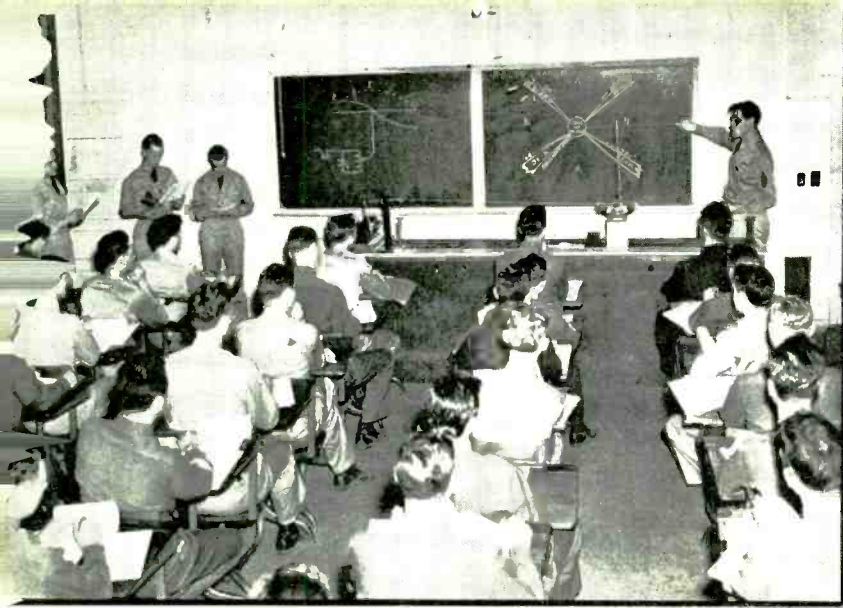

Class-room instruction is given on radio transmitters, and particular emphasis is placed on the use of radio beacon direction finding methods

A class of students listens to an instructor explain the method of installing an antenna on an Army bomber



## Training For Air Corps Communication



A laboratory class in radio compass work. A complete radio transmitter and receiver are available at each bench position. The line of dirigibles at the left are a group of "tear drop" loop antennas

The flying class room at Scott Field. Each student learns to develop proficiency in land-to-ground communication



**S**COTT FIELD, near Belleville, in the southern prairie section of Illinois, trains the men who are to be the ears of the Air Corps. This rapidly growing military post (recently transformed from a mile square field to an instruction center of 2300 acres) houses the Radio Communications School of the Air Corps. Here approximately 5,000 enlisted men have come from Army air posts throughout the country for a 22-week course in radio communication.



# BANDWIDTH FACTORS FOR CASCADE TUNED CIRCUITS

By C. E. DEAN

Hazeltine Service Corp.

**C**ALCULATIONS of bandwidth at a given deviation from resonance for cascade tuned circuits may be quickly and conveniently carried out by means of the table, and equations, given in this Reference Sheet. A pair of graphs, providing the same data as that of the tables, but which may be useful for interpolated values not contained in the table, is also included. This data was originally prepared several years ago by Harold A. Wheeler of the Hazeltine Service Corp. and has been found a useful tool in several laboratories engaged in the development of radio apparatus.

From the data in this Reference Sheet, the engineer may determine the bandwidth for a specified attenuation if the resonant frequency, the  $Q$  of the circuits, and the type of

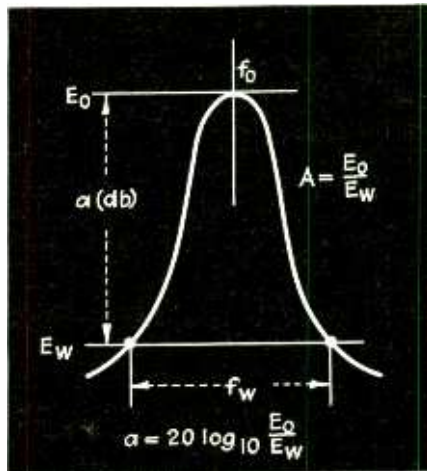

Typical resonance curve with voltages, frequencies and attenuations indicated

tuned circuits are known. Likewise, the required circuit  $Q$  can be obtained when the degree of coupling, attenuation, and bandwidth are specified for a given resonant frequency.

In the diagram above, represent-

ing a typical resonance curve, let  $f_0$  be the resonant frequency of all circuits,

$f_w$  be the overall bandwidth in the same units as  $f_0$ ,

$E_0$  be the voltage at resonance,  $E_w$  be the voltage at the extremities of the desired bandwidth

$A$  be the attenuation, expressed as the voltage ratio,  $E_0/E_w$

$a$  be the attenuation expressed in db, ie,  $a = 20 \log_{10} A$

$n$  be the total number of resonant circuits,

$W$  be the bandwidth factor obtained from the table or graphs

$Q$  be the circuit quality defined by  $Q = \omega L/R = Wf_0/f_w$

The equations which are the basis for the table are

$$f_w = Wf_0/Q \quad (1)$$

and for circuits of very loose coupling,

$$W = (A^{2/n} - 1)^{1/2} \quad (2)$$

$$A = (1 + W^2)^{n/2} \quad (3)$$

Total Number of Circuits $n$	BANDWIDTH FACTOR, $W$												
	$A=1.12$ $a=1$ db	$A=1.26$ $a=2$ db	$A=1.41$ $a=3$ db	$A=2$ $a=6$ db	$A=4$ $a=12$ db	$A=7$ $a=17$ db	$A=10$ $a=20$ db	$A=20$ $a=26$ db	$A=40$ $a=32$ db	$A=70$ $a=37$ db	$A=100$ $a=40$ db	$A=1000$ $a=60$ db	$A=10^4$ $a=80$ db
CIRCUITS OF EQUAL INDIVIDUAL SELECTIVITY VERY LOOSELY COUPLED OR CASCADED IN SUCCESSIVE STAGES OF AN AMPLIFIER													
1	0.51	0.77	1.00	1.73	3.9	6.9	10						
2	0.35	0.51	0.64	1.00	1.7	2.2	3	4.4	6.3	8.3	10		
3	0.28	0.41	0.51	0.77	1.2	1.7	1.9	2.5	3.3	4.0	4.5	10	
4	0.24	0.35	0.44	0.64	1.0	1.3	1.5	1.9	2.3	2.7	3.0	5.5	10
5	0.22	0.31	0.39	0.57	0.86	1.1	1.2	1.5	1.8	2.1	2.3	3.9	6.3
6	0.20	0.28	0.35	0.51	0.77	0.96	1.1	1.3	1.6	1.8	1.9	3.0	4.6
7	0.18	0.26	0.32	0.47	0.70	0.86	0.96	1.16	1.4	1.54	1.65	2.5	3.6
8	0.17	0.24	0.30	0.44	0.64	0.79	0.88	1.06	1.23	1.38	1.47	2.2	3.0
CIRCUITS OF EQUAL INDIVIDUAL SELECTIVITY OPTIMUM-COUPLED IN PAIRS													
2 (1 pair)	1.01	1.24	1.4	1.9	2.8	3.7	4.5	6.2	9.0				
4 (2 pairs)	0.84	1.01	1.1	1.4	1.9	2.2	2.5	3.0	3.5	4.1	4.5	8.0	
6 (3 pairs)	0.75	0.90	1.0	1.2	1.6	1.8	2.0	2.3	2.6	2.8	3.1	4.5	6.6
8 (4 pairs)	0.70	0.84	0.93	1.13	1.4	1.6	1.7	1.9	2.2	2.3	2.5	3.5	4.5

ELECTRONICS REFERENCE SHEET

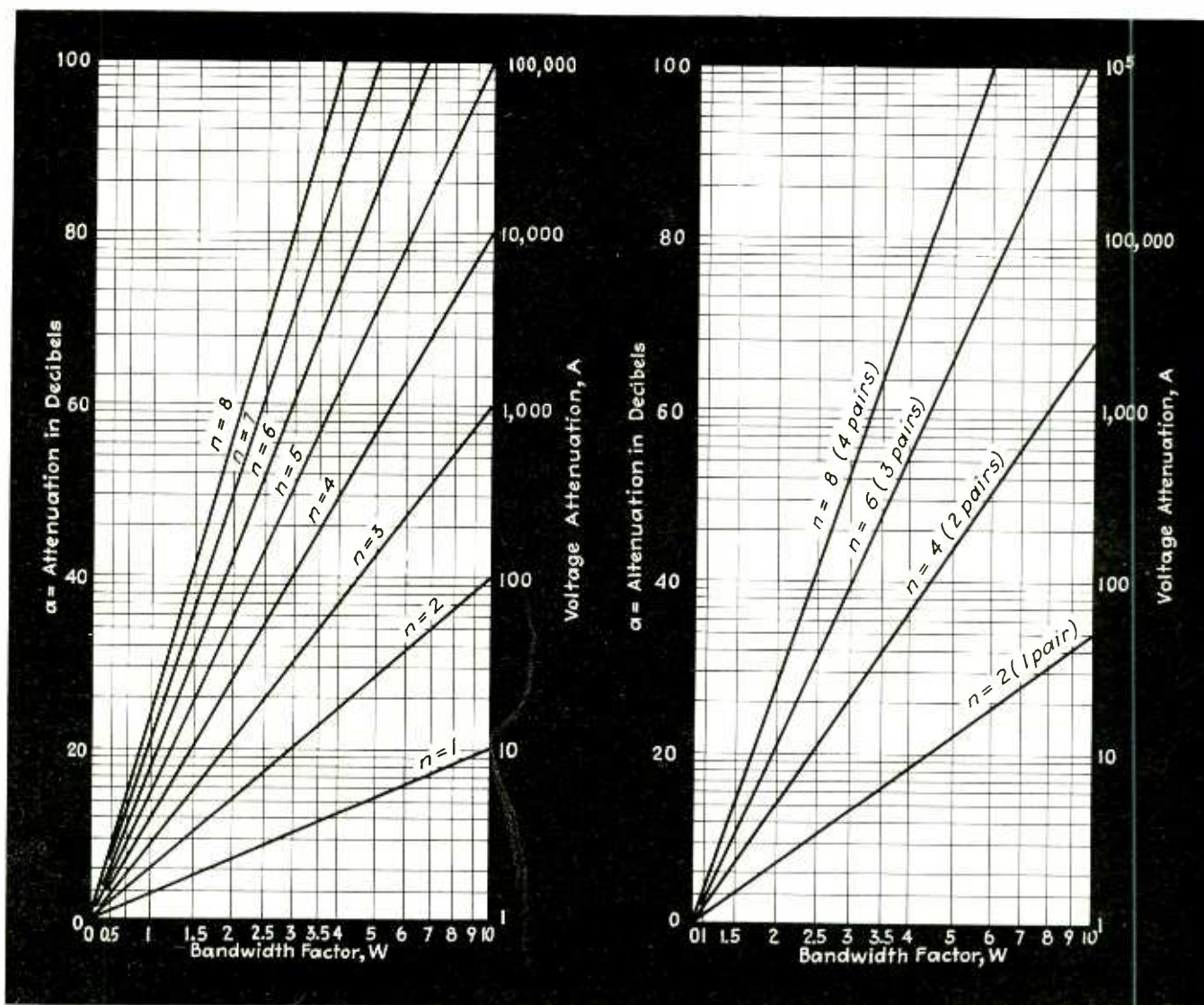

Attenuation and bandwidth factors for loosely-coupled cascaded tuned circuits

Attenuation and bandwidth factors for cascaded circuits, optimum coupled, in pairs

for circuits of optimum coupling,

$$W = \sqrt{2(A^{1/n} - 1)} \quad (4)$$

$$A = (1 - W^2/4)^{n/4} \quad (5)$$

The method of using the tables and graphs can best be illustrated by considering a few typical examples.

1. Given a tuned r-f amplifier of one stage with input and output circuits each with a  $Q$  of 100, determine the bandwidth 20 db down if the resonant frequency is 1000 kc and circuits are loosely coupled.

From the table for loosely coupled circuits and an attenuation,  $a = 20$  db we find that  $W = 3$ . Then, from Eq. (1) we have,  $f_w = 3 \times 1000/100 = 30$  kc.

2. Given an i-f amplifier with four tuned circuits in two pairs, all tuned to 455 kc and having a  $Q$  of 90, de-

termine the bandwidth 40 db down for optimum coupling.

From the table for optimum coupled circuits,  $W = 4.5$ , and from Eq. (1) we find the bandwidth to be,  $f_w = 4.5 \times 455/90 = 22.7$  kc.

3. It is required that one pair of optimum-coupled i-f circuits have a bandwidth of 18 kc at 20 db down when the resonant frequency is 455 kc. What is the required  $Q$ ?

From Eq. (1),  $Q = Wf_w/f_w = 4.5 \times 455/18 = 113$ .

4. It is required that an amplifier have a bandwidth of 10 kc at 6 db and an attenuation of at least 60 db for a bandwidth of 60 kc. Determine the circuit arrangement and required  $Q$  for operation at 455 kc.

In terms of bandwidth,  $(f_w)_{60} \leq 6(f_w)_6$ , or  $W_{60}f_w/Q \leq 6W_6f_w/Q$ , where

the new subscripts indicate the attenuation in decibels. It is seen that  $f_w$  and  $Q$  cancel, leaving the requirement,  $W_{60}/W_6 \leq 6$ . From the table we obtain the following data:

Circuits	$W_n$	$W_{60}$	$W_{60}/W_n$
5 separate, loosely coupled	0.57	3.9	6.8
6 separate, loosely coupled	0.51	3.0	5.9
4 in pairs, optimum-coupled	1.4	8.0	5.7
6 in pairs, optimum-coupled	1.2	4.5	3.8

Six separate circuits would be required, but four circuits in pairs are adequate and might be chosen.

For this problem, the necessary  $Q$  is determined by the required 10-kc bandwidth at 6 db from Eq. (1),  $Q = Wf_w/f_w = 1.4 \times 455/10 = 64$ .

## ELECTRONICS REFERENCE SHEET



CINCH MOLDED SOCKETS...

# A Bullseye EVERY ONE!

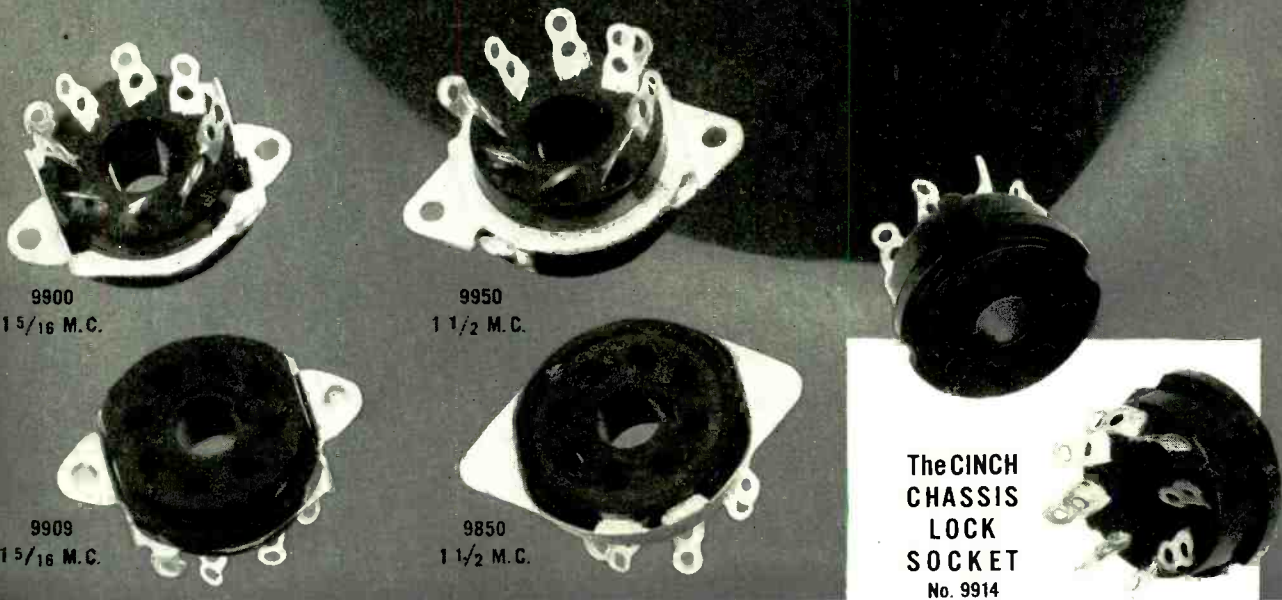

## ... A HIT EVERY TIME!

A sure hit...skillfully designed to fit the requirement, durably made to give lasting satisfaction. CINCH molded sockets are available with saddles for customary riveting to chassis...also for spot welding...and in the chassis lock design. In these trim, space saving sockets are embodied "CINCH" distinctive features, CINCH solder coating, and the best material and workmanship.

Where the preference has been for this type of Molded Socket, it has been found that CINCH effects economies; in original investment, in handling—no rivets or eyelets are required for assembling to chassis—a saving in space and assembly costs, and in the metal and rivets. The socket is locked firmly in place by lugs sheared up from chassis itself.

*CINCH Molded Sockets are licensed under American Phenolic Corp. Patents*

**Cinch**

SUBSIDIARY OF UNITED-CARR FASTENER CORP., CAMBRIDGE, MASS.

**MANUFACTURING CORPORATION**

2335 WEST VAN BUREN STREET, CHICAGO, ILLINOIS

**NEW**

# Operating Convenience

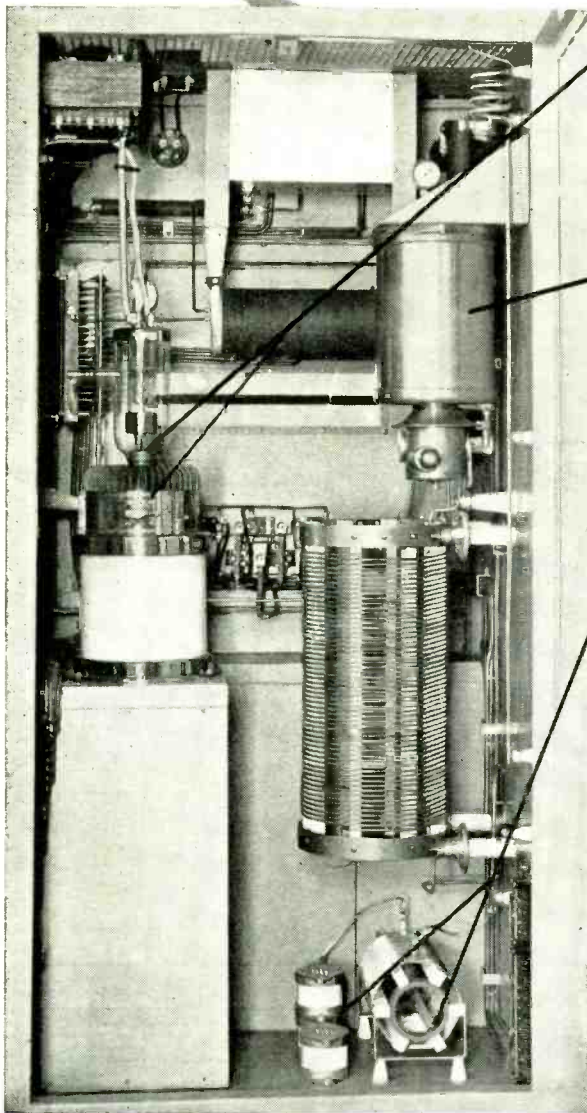

★ **THE 892-R POWER** amplifier tube, air-cooled, is easily reached when the rear door of the radio frequency power amplifier cubicle is opened.

★ **VARIABLE COMPRESSED GAS CONDENSER** used in the final radio frequency stages has short leads, low losses, complete shielding and provides a wide range of tuning.

★ **PI NET - WORK** easy to adjust. R. F. harmonic reducing Pi network is preset at the factory but has convenient taps for final adjustment on the job.

Open the front and rear doors of the new Westinghouse 5-HV 5000-watt radio broadcast transmitter and you see at a glance one good reason why it is being chosen for modern, up-to-the-minute broadcasting stations. Every part is fully accessible—every part fits to make a compact unit, but with no crowding—every adjustment is within easy reach. The power amplifier cubicle, illustrated at the left, is typical of the rear door accessibility of the 5-HV.

**ATTRACTIVE** to look at—but its beauty is more than skin deep and goes far beyond the panel finish. Its operating advantages are attractive to men who are responsible for the operation, inspection and maintenance of a radio station—advantages built in by the same engineers who designed the Westinghouse 50-HG which aroused such widespread interest when it was installed in KDKA slightly over a year ago.

**METAL RECTIFIERS** used in *all* of the low voltage plate and bias power supply circuits eliminate replacement trouble and expense and insure against unpredictable rectifier tube failures.

## OPERATING ADVANTAGES

- Air-cooled tubes in all stages.
- Low operating costs.
- Except for the rectifier supplying power to the amplifier and the class "B" modulator, metal rectifiers are employed throughout.
- Inductive neutralization is employed in all radio frequency stages requiring neutralization.
- Equalized feedback.
- Compressed gas condenser.
- Complete fuseless overload protection.
- Simplified circuit adjustments.
- Automatic control is realized.
- Conservative operation of all tubes.
- Current and voltage indicators are provided in all circuits where such instruments are normally desired.
- Split second switching to 1-KW reduced power.



# Westinghouse



# WESTINGHOUSE 5HV SETS A NEW STANDARD IN ACCESSIBILITY

**UNDIVIDED RESPONSIBILITY**—In addition to complete broadcast transmitters, Westinghouse makes ALL the other equipment required for *transmitting* station operation, including tower lighting, antenna phasing and tuning, power input apparatus, switchgear, and station lighting. No matter what your problem may be, Westinghouse has the experience and the apparatus to give you exactly what you need. Call your nearest Westinghouse office.

**EXCITER CUBICLE**—Two doors and a drop leaf give ready access to all controls, instruments, tubes—all you need to touch or see to adjust exciter for operation. Inclined panelboard makes it easy to read the instruments.

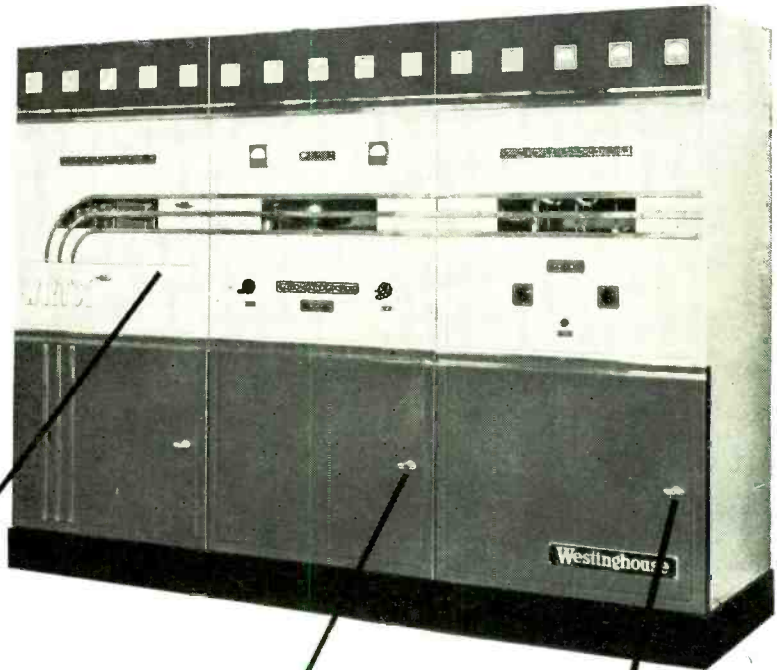
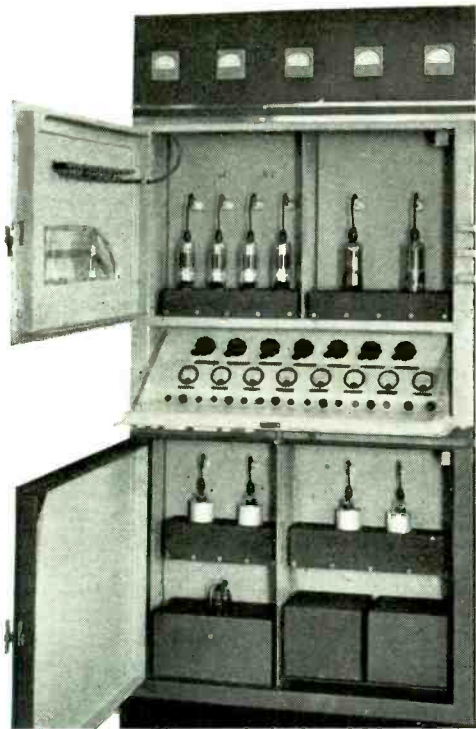

**POWER AMPLIFIER CUBICLE**  
—Lower door opens to make it easy to check relay operation.

**MODULATOR CUBICLE**—Tubes and their supporting sockets are instantly available through lower door.

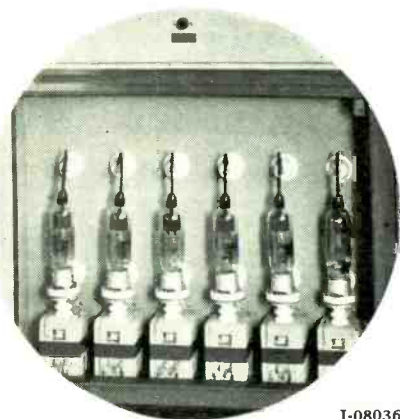
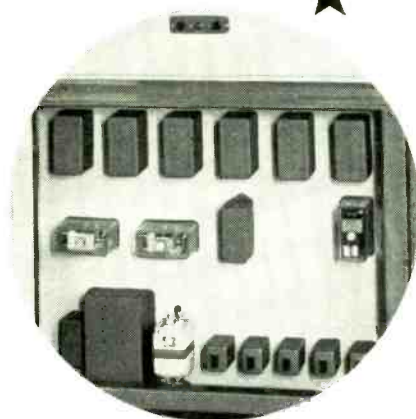

J-08036-A

## BROADCAST EQUIPMENT

# TUBES AT WORK

**Radio cars for BMT surface lines, a square wave generator, a voltage attenuator, regeneration in mixer stages, an electronic view finder, and x-ray tube filament voltage regulation are discussed**



Interior of radio patrol car used to dispatch trolleys and buses

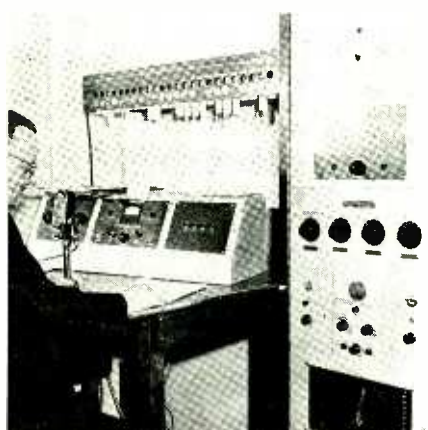

The dispatcher's office which is in constant touch with the radio cars

## Radio Speeds Up Traffic

TWENTY PATROL CARS have been equipped with two-way police radios by the Westinghouse Electric and Manufacturing Co. for the Brooklyn & Queens Division of the New York Transit System to facilitate line dispatching of trolleys and buses. The equipment makes it easy to cope with traffic emergencies. Recently when a downtown fire threatened to block the converging point of four bus and trolley lines, a radio dispatcher communicated with three patrol cars and diverted all but two trolleys through parallel streets thus preventing interruption of passenger service.

The Brooklyn & Queens surface system, serves an area approximately eight by 16 miles. It uses 1,235 street cars and 300 buses. Of the 175 street supervisors, 20 drive radio patrol cars, and each car is operated by one man. The cars carry fuses, cable, a 10-ton jack and other emergency equipment. Ten of the patrol cars have 15-watt transmitters, as well as receiving sets. The other 10 cruisers have receiving sets only. There are receiving sets on five heavy emergency trucks, one light emergency truck, two line department automobiles and one track patrol car.

The dispatching equipment consists of a 50-watt transmitter with its antenna on top of a building near the heart of the patrolled area. Its call letters are WRWH, and it operates on a frequency of 31.46 Mc. It is operated by remote control from the dispatcher's office at the headquarters of the system. At the dispatcher's desk are seven automatic recorders which check the

dashboard, are tuned to the dispatcher's 31.46 Mc. When reporting to the dispatcher, cruising car drivers speak into a cradle telephone attached to the car's steering wheel. Transmitting equipment is behind the driver's seat.

Between 50 and 100 calls are issued during the average 24 hour day. Regulations of the Federal Communications Commission provides that only emergency calls be issued. The most common type of emergency is a blockade of the tracks when two vehicles collide. The most serious emergencies occur when downtown fires block a main line. The dispatcher receives fire alarm signals simultaneously with the fire department.

• • •

## A Simple 60 Cycle Square Wave Generator

By KARL H. MARTIN

VIDEO AMPLIFIERS IN TELEVISION transmitters and receivers must have low frequency phase and gain characteristics suitable for the faithful transmission of the vertical blanking and the background level of the video signal. The frequencies included in this range extend from 20 or 30 cycles per second up to 100 or 200 cycles per second. The simplest method of checking the low frequency phase and gain characteristic of the video amplifier is to apply a 60 cycle square wave to the input of the amplifier and observe the output waveform on a good cathode ray oscilloscope. If the wave is transmitted by the amplifier without distortion, it has satisfactory low frequency gain and phase characteristics for the faithful trans-

## BRITISH ARMY AND R.A.F. COOPERATE



In England, cooperation between the Army and the R.A.F. is highly organized. The man at the desk is an R.A.F. instructor, who is assisting in the training of an Army pilot in the Link trainer which simulates actual conditions of flight even though the pilot and his craft do not leave the ground



# MEAT WITHOUT MOLD!



a **SPERTI** achievement  
to which **CALLITE** contributed

FOR years, those extra-tender juicy steaks have been the result of refrigerator "hanging" until enzyme action had rendered the meat sufficiently tender. This process was accompanied, however, by a profuse growth of mold.

Today's meat is "tenderized" scientifically in refrigerators equipped with Sperti Mercolites. These special mercury vapor lamps emit powerful ultra-violet radiation in a selected band in the region of 2537 A.U. This radiation not only kills surface bacteria, but also inhibits the growth of mold, allowing tenderizing enzymes in the meat to act without mold and without spoilage.

Because Callite products are constantly proving their superiority in literally thousands of electronic applications, Sperti engineers use uniformly dependable Callite grids, welds, leads, and other materials in the manufacture of Mercolites. Perhaps some of the products or processes under your direction may be further improved with Callite products. Why not write today?

*Manufacturers of electrical contacts of refractory and precious metals, bi-metals, lead-in wires, filaments and grids—formed parts and raw materials for all electronic applications.*

## CALLITE TUNGSTEN CORPORATION

544-39th STREET UNION CITY, N. J.

CABLE: **CT** "CALLITES"

BRANCHES: CHICAGO • CLEVELAND

mission of the low frequency components of a video signal.

The circuit diagram of a simple 60 cycle square wave generator is shown in Fig. 1. It consists of a two stage resistance-coupled amplifier. A 60-cycle sine wave is applied to the input of the amplifier. The positive and negative peaks of the sine wave are clipped off by the amplifier. The output is a square wave and is shown in Fig. 2. The output of the square wave generator can be obtained from either the cathode or

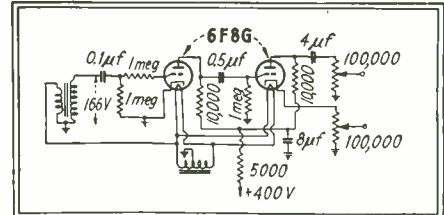

Fig. 1—Generator circuit diagram

plate circuit of the second stage. Both stages are grid-leak biased. The second stage has degenerative cathode bias as well.

The 60-cycle sinusoidal signal applied to the grid of the first tube has an amplitude of approximately 150 volts rms. This voltage is obtained from the heater supply by means of a step-up transformer. The transformer is a plate-to-voice coil coupling transformer and has a turn ratio of approximately 50 to one.

The grid of the first tube is driven beyond cutoff on the negative peaks, and positive on the positive peaks. Grid current flows on the positive peaks

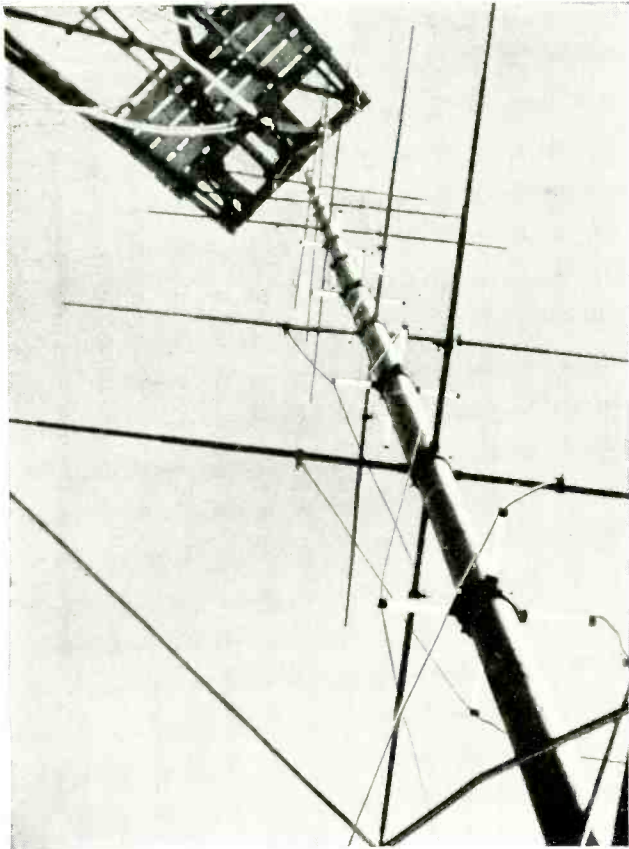

Fig. 2—Oscillogram of output

and the input impedance of the tube becomes small in comparison with the one megohm resistance in series with the grid. This resistance and the input impedance of the tube act as a potential divider or attenuator and therefore only a very small fraction of the applied positive voltage appears between the grid and cathode. Thus the amplitude of positive peak applied between grid and cathode is reduced to a very low level. The resulting plate current-grid voltage characteristic when the plate current is plotted against the

*(Continued on page 52)*





(Above) OUTSTANDING ADVANCE in radio engineering has been the development of FM. Isolantite\*, with its outstanding mechanical, thermal, and electrical properties which make it ideal for ultra-high frequency service, has been identified with this important development ever since its beginning. Photo shows Isolantite stand-off insulators on one of the turnstiles of Major E. H. Armstrong's experimental station W2XMN at Alpine, N. J.

(Below) IN THIS INDUCTION Coil Assembly, made by Collins Radio, Isolantite bar inductance supports an air-gap stand-off insulators contribute to ruggedness of design and reduction in power losses. Accuracy of size and location of winding slots is an outstanding advantage of large Isolantite inductance bars and makes for improved electrical design and mechanical assembly.

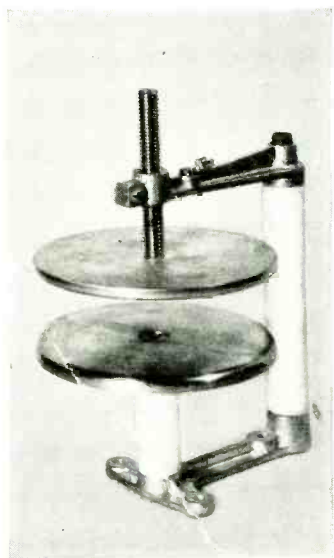

(Above) HIGH STRENGTH and mechanical precision of Isolantite are utilized to good advantage in the design of this air-gap condenser built by National Company, Inc. Isolantite insulation is the choice of many of the leading manufacturers of all types of condensers, and of other component parts of communications equipment. If special insulator designs are needed they can frequently be produced economically.

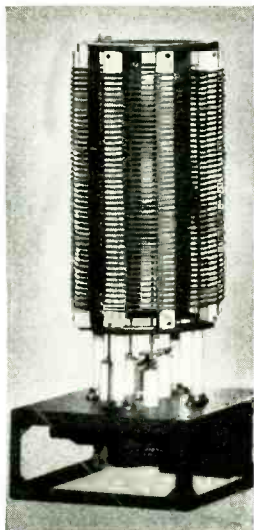

# INSULATION HIGHLIGHTS

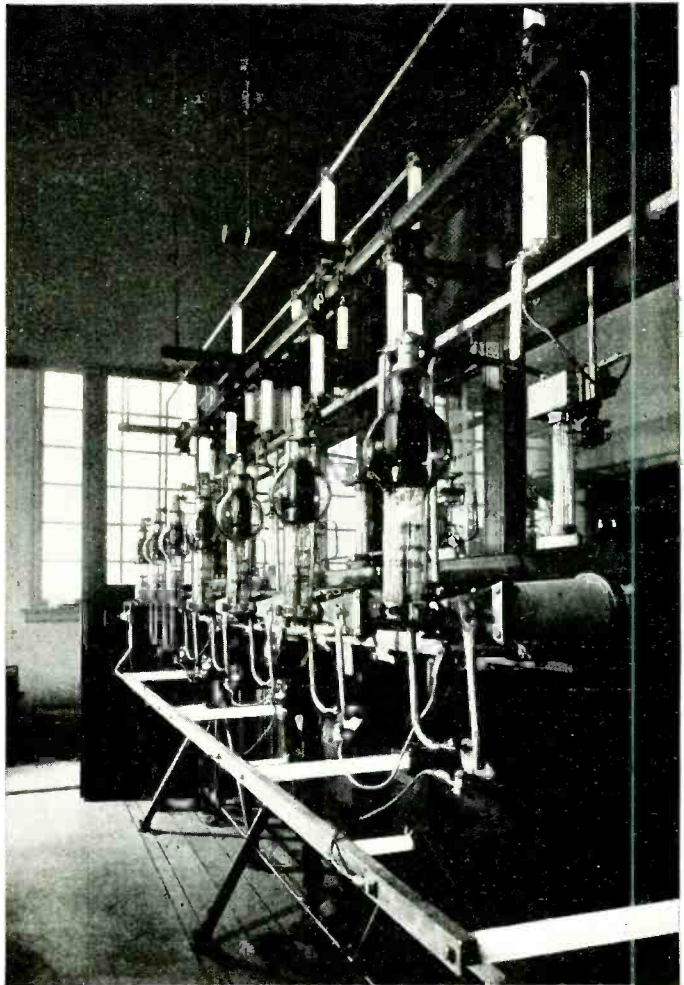

(Above) HIGH-VOLTAGE RECTIFYING UNITS make liberal use of Isolantite, because of its high mechanical strength and low power losses. Unit shown forms part of the 50 KW transmitting unit built by Western Electric for Station WHAS, Louisville.

\*Registered trade-name for the products of Isolantite, Inc.

# ISOLANTITE

## CERAMIC INSULATORS

ISOLANTITE, INC. FACTORY: BELLEVILLE, NEW JERSEY  
SALES OFFICES: 233 BROADWAY, NEW YORK, N. Y.





## Sorry, Mister Janus

Mr. Janus, the old Romans said, was a smart guy. But why not, being double-headed as he was? ¶ We were thinking the other day that it would be handy to have him around. And then taking stock, we decided we could dispense with the idea because here at Collins we have

not two but many heads. ¶ Our recently expanded factory is manned by a skillful personnel trained to build radio equipment of excellence. Collins engineering department abounds in every kind of mechanical and electrical proficiency.

**COLLINS RADIO COMPANY**  
CEDAR RAPIDS, IOWA NEW YORK, N. Y.: 11 WEST 42 ST.

# New Books

## Electromagnetic Devices

By HERBERT C. ROTORS. John Wiley and Sons, New York, 561 pages. Illustrated. Price \$6.00.

THIS VOLUME FILLS a long-felt need for a quantitative treatment of the design of magnetic circuits especially as employed in the construction of non-rotating electromagnetic devices. Undoubtedly the difficulty of accurately solving magnetic circuits because of the non-linear relationships involved in magnetic materials, and the effects of magnetic leakage have placed the accurate theoretical design of magnetic circuits beyond the capabilities and time limitations of the average engineer, and has likewise been responsible for much guesswork and trial and error methods. But both the theoretical and practical aspects of the problem are so ably discussed in "Electromagnetic Devices" that this volume well marks a new land-mark in its field.

In one respect, the book is sadly out of tune with certain signs of our time, for there is little of the light reading pap contained in it which, it is often believed, must be liberally sprinkled around so that education may be made more palatable. The reader is advised in the preface that, "a familiar knowledge of the subject matter generally taught in undergraduate courses in electrical engineering is assumed", and the strides from that point on are logical and direct.

The first eight chapters deal with the fundamental theory and methods of analysis which are generally applicable to all magnetic circuits. The last six chapters are devoted to the design of electromagnets in which the principles developed in the early part of the book are applied. The author has given the results of typical designs (many of which have been taken from his consulting practice) as a guide to the student and engineer in following through his own problems. Throughout the book a thoroughly practical point of view is maintained. In more than the customary number of instances, theory is checked with practice by experimental measurements, and, where deviations occur, they are accounted for by suitable explanation.

Readers of ELECTRONICS will probably find Chapter IX and X, dealing with the characteristics and design of tractive magnets of less utility than the last four chapters which discuss, respectively, time-delayed magnets,

high-speed magnets, alternating-current magnets, and relays. Indeed, the last chapter will be invaluable background material for any engineer doing design work in the industrial fields of electronics where relays are operated from the plate circuit of electron tubes.

Throughout the book a considerable amount of data is given on such matters as characteristics of magnet wire, winding data, the magnetic characteristics of ferro-magnetic substances, determination of various losses, etc. An appendix giving a brief outline of the fundamental physical concepts, and a 29-page index complete the volume.

For the graduate student or the practicing engineers to whom the book is directed, "Electromagnetic Devices" is well recommended.—B. D.

## Fessenden—Builder of Tomorrows

By Helen M. Fessenden. Published by Coward-McCann, Inc., New York, 1940. 362 pages, illustrated, map end-papers. Price \$3.00.

THIS BIOGRAPHY of Reginald A. Fessenden, written by his wife, is intended for the general public, but it should make especially interesting reading for those whose profession is radio. Old-timers are well aware of the prodigious output of invention for which Professor Fessenden is responsible, but the youngsters may not know that he ranks with Marconi, Lodge, DeForest, Armstrong, and the other great names of the art. He coined the word heterodyne to describe his invention of radio reception by the beat method, he was among the first to understand the importance of the continuous wave and to build apparatus capable of operating on the c-w principle. His high-frequency alternator antedated Alexanderson's by several years. He was certainly among the first to transmit wireless telephony. Some give him credit for the invention of radio telephony—others dispute it—but all agree that his Brant Rock broadcasts in 1906 were among the earliest examples of gathering together a widespread audience by radio telephone. His inventions in submarine signalling and depth-sounding, which came in later years, were and still are of the greatest importance to marine navigation and safety.

A book of this type, written by the wife of the subject of the story, is not expected to be a critical appraisal. No doubt there are many in the industry who would take issue with the author concerning the responsibility for various inventions. This is inevitable, since many conflicting claims, most of them honestly urged, surround the early history of the art. But the book is a well written and interesting record of an outstanding personality, even if it is not a definitive study of early radio inventions. The informed reader will, of course, wish for more technical information than could properly be included in a book for the general public but this lack is fully made up in the anecdote and philosophy with which the book abounds. It is well worth the attention of everyone in radio.—D.G.F.

## Men and Volts: The Story of General Electric

By JOHN WINTHROP HAMMOND, edited and condensed by ARTHUR POUND. Published by J. B. Lippincott Company, New York City, 1941. 436 pages and many illustrations. Price \$2.50.

STARTING WITH THE DAYS of horse cars and gas lights, this book describes in absorbing fashion the invention and application of the arc light, incandescent light, street cars, and other electrical devices, including the work of Thomson, Houston, Brush and Edison. From this point the story goes on to the formation and history of the Thompson-Houston Company and the Edison General Electric Company, from whose merger in 1892 the General Electric Company was formed. Throughout, the emphasis is on inventors, engineers, manufacturing personnel, and the related technical topics. With coverage of the entire period from the beginnings to 1922 and the wide range of lamps, generators, distribution systems, transformers, motors, and other apparatus, there is all too little space for detailed discussion of any one subject. But the main technical and human facts are given, so that the reader in hurrying from one development to the next shares the thrill of the rapid course of events in those days. The period since 1922 is covered very briefly in the last of the volume.

The fields covered include also turbines, welding, electric ship propulsion, railroad electrification, and automatic substations, so that, for the most part, the volume is a power-engineering history. However, there are short accounts of the electronic work of Langmuir on the high-vacuum tube, Coolidge on the x-ray tube, and Alexanderson on the radio-frequency alternator and the multiple-tuned antenna.

The book is excellent as background and cultural reading for the electronic specialist. And its interesting style, inclusion of human aspects, and general accuracy make its perusal a pleasure rather than a duty.—C.E.N.



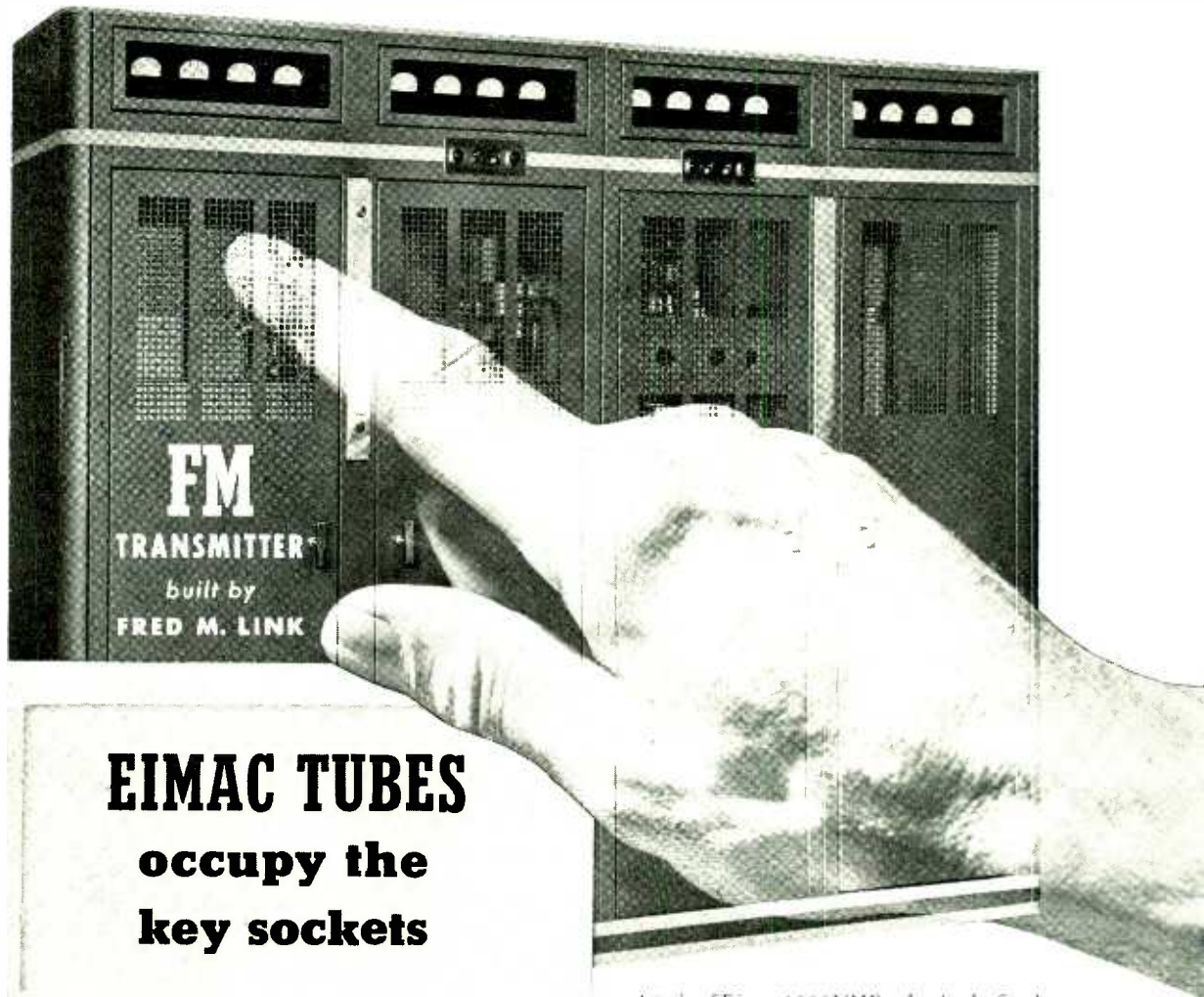

## EIMAC TUBES occupy the key sockets

*A pair of Eimac 1000UHF tubes in the final and an Eimac 250TH in the exciter stage.*

First choice in most all the new developments in radio communications, Eimac tubes have been continuously used by the pioneers in Frequency Modulation. This "Link" 3000-UFS 3 Kilowatt FM transmitter, built for the emergency services utilizes a pair of Eimac 1000UHF tubes in the final class "C" stage. The tubes operate at 40 megacycles and work well within their normal ratings. The standard "Link" 250-UFS 250 watt FM transmitter is used as an exciter for the final stage and uses an Eimac 250-TH in its output.

Long recognized for its record of producing high quality transmitting equipment, the

Fred M. Link organization has had and continues to have outstanding success with Eimac tubes. Unusual performance capabilities, long life and complete freedom from premature failures caused by gas released internally . . . they're unconditionally guaranteed against such failures . . . has made them first choice among the world's leading radio engineers.

Follow the Leaders to

**Eimac**  
TUBES

Eitel - McCullough, Inc. • San Bruno, California

### EIMAC REPRESENTATIVES

California, Nevada  
HERB BECKER, 1530 W.  
104th St., Los Angeles, Cal.  
N. Y., N. J., Penn., Md., Del.,  
Dist. of Col., Maine, N. H.,  
R. I., Conn., Mass.  
ADOLPH SCHWARTZ,  
14726 Elm Ave., Flushing,  
New York.

Wash., Ore., Idaho, Mont.  
GENERAL SALES CO.,  
Verner O. Jensen, 2605-07  
Second Ave., Seattle, Wash.

Colo., Wyo., New Mexico,  
Arizona, Utah  
RICHARD A. HYDE, 4253  
Quitman St., Denver, Colo.

Chicago, Illinois, Wisconsin  
G. G. RYAN, 549 W.  
Washington Blvd., Chicago,  
Ill.

N. Caro., S. Caro., Georgia,  
Tenn., Flor., Ala., Miss.  
JAMES MILLAR, 316 Ninth  
St. N. E., Atlanta, Georgia.

Texas, La., Okla., Ark.  
J. EARL SMITH, 2821 Live  
Oak St., Dallas, Texas.

Ohio, Mich., Ky., Ind., Minn.,  
Mo., Kan., Neb., Iowa  
PEEL SALES ENGINEER-  
ING CO., E. R. Peel, 154  
E. Erie St., Chicago, Ill.

Export Agents: Frazer & Co., Ltd., 301 Clay Street, San Francisco

# HIGH SPEED—LOW COST MEASUREMENTS



**IMPORTANT NEW DEVELOPMENTS IN TEST EQUIPMENT SAVES YOU TIME AND MONEY**

hp resistance tuned audio oscillators set a new standard of performance in laboratory and field testing. The saving of time, extreme accuracy and versatility of measurements coupled with low cost makes them the most profitable investment in the electronics field.

hp—instruments are the result of long research in a well equipped laboratory and have been thoroughly tested both in the laboratory and the field. You'll profit in many ways by investigating, at once, the advantages of these new instruments. Write today for data sheets. There's no obligation of course.

Laboratory  
**INSTRUMENTS**  
for speed and accuracy

**HEWLETT-PACKARD CO.**  
481 Page Mill Rd., Palo Alto, Calif.

**No. 205 AG Audio Signal Generator.**  
*Combines a Resistance tuned oscillator having 5 watts output and less than 1% distortion, plus Output meter, Input meter, Attenuator and an impedance matching system... all in a single unit. Price \$340 Net.*

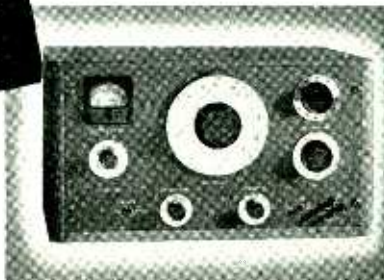

**No. 205A Audio Signal Generator.** *Identical in every respect to the 205AG with the exception of the input gain set which is not included. Price \$290 Net.*

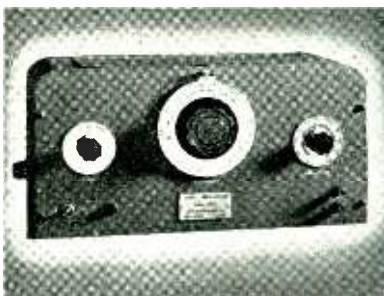

**Series 200 Resistance Tuned Oscillators.**  
*Consists of hp Resistance Tuned Oscillator only. Available in cabinet or for relay rack mounting in models A, B, C & D, covering frequency range from 7 cps. to 200 kc. Priced \$85.50 to \$130 Net.*

## Resistance Tuned Principle

A stabilized amplifier with regeneration supplied through a frequency selective resistance capacity network. The oscillation frequency is stable and the thermal drift extremely low. Furthermore, the thermal drift is not magnified as is the case with the beat frequency oscillator. A balancing circuit automatically selects the proper operating point for the oscillator. The result—a stable oscillator having constant output and very low distortion. Whether for low frequencies, geophysical work or high frequencies in the super-sonic region—resistance tuning is vastly superior. Send us your problems requiring audio frequency or super-sonic oscillators.

Write today... No obligation

voltage (applied between point A and ground in Fig. 1) is shown in Fig. 3.

The grid condenser charges during the positive peak and discharges through the grid leak during the negative peak. The resulting negative bias is constant during the negative peak as the discharge time constant (0.1 second) is large compared to the duration of the negative peak. Thus the operating point on the plate current-grid voltage characteristic shown in Fig. 3 is shifted near or beyond cutoff.

The waveform of the plate current, produced when a sine wave of approxi-

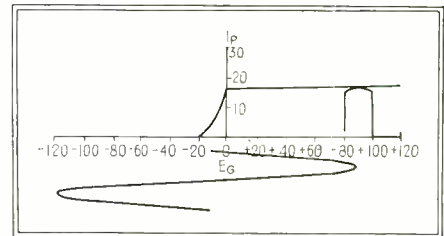

**Fig. 3—Plate current-grid voltage characteristic of the first tube**

mately 100 volts peak is applied between point A and ground, is also shown in Fig. 3. This waveform is a fair approximation of a square wave. The waveform of the output voltage of the first tube is like the plate current waveform except that it differs in phase with the plate current by 180 deg. The positive peak of the output is flat topped and the negative peak is rounded. Also an interval of several electrical degrees is required, for the voltage to change from maximum to minimum. The peak to peak amplitude is approximately 170 volts.

This high amplitude signal is applied to the second stage and only the tops of the positive peaks are effective in causing a plate current change. The grid condenser of the second stage is charged on the positive peaks to a voltage which is approximately equal to the magnitude of the positive peak. This condenser discharges through the grid leak during the negative peak and the resulting negative bias is essen-

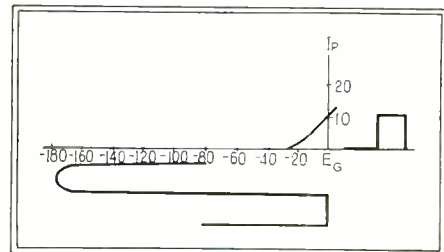

**Fig. 4—Plate current-grid voltage characteristic of the second tube. Note the square shape of the plate current pulse**

tially equal in magnitude to the positive peak. Thus the positive peaks just drive the grid of the second tube to slightly above zero. The plate current-grid voltage characteristic of the second stage, and its operation is shown in Fig. 4. The plate current waveform is a good square wave.



# CABINET FOR ZENITH POKETRADIO

## Gains Sturdiness with Lightness in Weight through use of "Bakelite" Plastic Parts

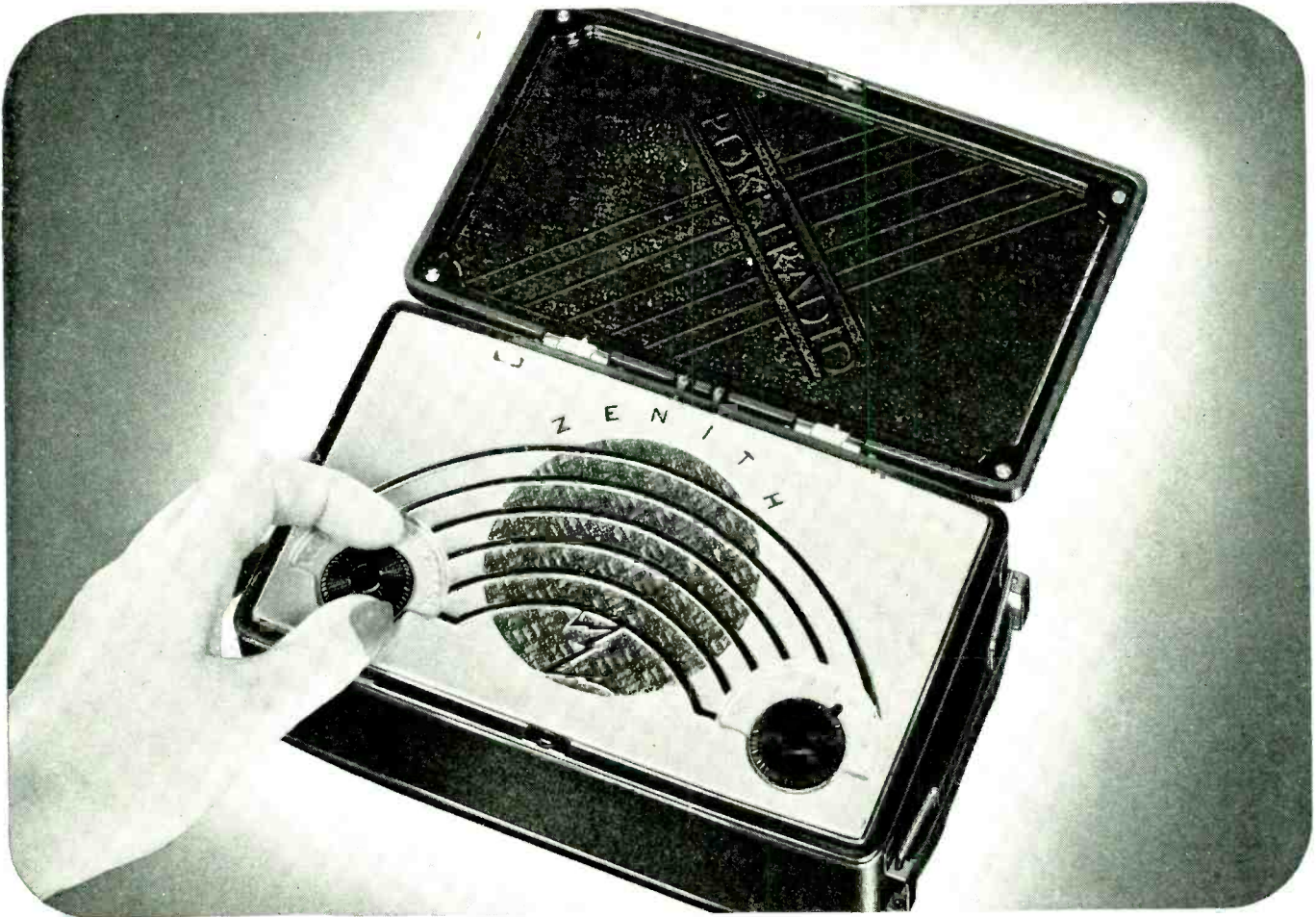

Hinged cover molded from BAKELITE impact-resistant Phenolic material by Chicago Die Mold Manufacturing Company. Antenna Loop Frame molded from BAKELITE Polystyrene.

THIS new Zenith Poketradio is designed to "go places." It must withstand a lot of knocking about in use. Size and strength, combined with lightness in weight, were important factors in its design.

The hinged cover is molded from a BAKELITE *impact-resistant* Phenolic. Although light in weight, it is very tough, and withstands the wear and tear of carefree outdoor use. It is dimensionally stable under varying climatic conditions and provides a dustproof, moistureproof seal for the receiver when the cover is closed. In addition, it has an attractive and lasting jet-black, lustrous finish.

Superior low-loss insulation for the antenna is obtained in a most compact form by enclosing the loop in a frame

molded from BAKELITE *Polystyrene*. This rectangular frame is easily assembled to the back of the Phenolic cover, thus saving valuable space.

Learn how these and other types of BAKELITE Plastics can be adapted advantageously to your requirements. Write for Booklet 10M, which describes these materials in detail.

BAKELITE CORPORATION  
Unit of Union Carbide and Carbon Corporation



30 EAST 42ND STREET, NEW YORK

# BAKELITE

TRADE MARKS  
The word "Bakelite" and the symbol are registered trade marks identifying products of Bakelite Corporation

**PLASTICS HEADQUARTERS**

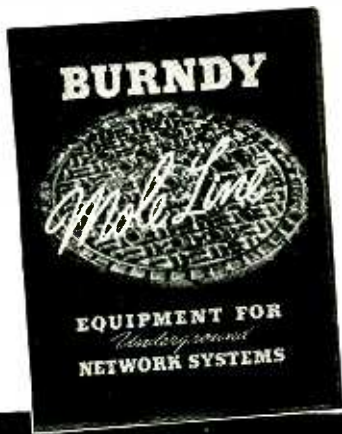

# BURNDY ENGINEERING *specifies* OIL STOP

**FOR OIL TIGHT  
ELECTRIC  
INSULATIONS**

- 7 Insert cable ends in Limiter sockets and indent in place with Hypress.
- 8 Wrap Limiter sockets, cable insulation and about 1 inch of lead sheath with two or three layers of 1/4" varnished cambric tape, coating each layer with Harvel Oil Stop or equal.
- 9 Place Asbestos Shells over Limiter being careful to center the shells on the fusible section.

In the Burndy Engineering Catalog on Mole Line Equipment for Underground Net Work Systems, OIL STOP is mentioned on Page 13 for use with installations of Burndy Limiters on Oil Impregnated Paper Insulated Cable.

OIL STOP is a phenol-aldehyde synthetic resin which has many uses in the electrical industry for cable splicing, low cost oil tight terminals, stop joints, insulating buses, cementing transformer gaskets, repairing cracked bushings, coil sealing, waterproof coatings, etc.

OIL STOP has the following qualities: completely seals against any kind of oil or water; easily applied as a liquid, yet polymerizes at ordinary temperatures into a firm enduring, infusible insulation—whether exposed to air or not; forms no vapor pockets during polymerization—being free of solvents; will not melt or soften after setting; resists vibration; has excellent adherence to rubber, oil-impregnated paper, molded plastics and fibre; has good adhesion to copper; and is not affected by acid or alkali solutions.

Supplied in the following container sizes:

#0 (1/4 pint); #1 (1/2 pint); #2 (1 pint);  
#3 (1 quart)



Write to Irvington Varnish & Insulator Company, Department 106 for complete information on this unusual insulation.

**IRVINGTON VARNISH & INSULATOR CO.**



IRVINGTON, NEW JERSEY, U. S. A.

PLANTS AT IRVINGTON, N. J. and HAMILTON, ONT., CAN.

Representatives in 20 Principal Cities

The output of the second stage can be obtained from either the plate circuit or the cathode circuit. The cathode circuit provides a low impedance source of low output while the plate circuit provides a high impedance source of high output. An oscillogram of the output is shown in Fig. 2.

This simple method cannot be used to convert high frequency audio sine waves into square waves because the series grid resistor to the first stage, in conjunction with the input capacity of the first tube, forms a low-pass filter. This filter causes frequency and phase distortion over the range of frequencies included in higher frequency square waves.

• • •

## Electronic Voltage Attenuator

By ESTEN MOEN

BY THE REVERSING OF the usual positions of grid as input and plate as output terminals in a vacuum tube amplifier, it is possible to provide the opposite of amplification, that is, to set up a divider or reducer connection. The measure of reduction or attenuation will be roughly the reciprocal of the amplification factor of the tube employed. Thus, the circuit shown herewith has two constant ratios, 1/20 for the 6C5 and 1/100 for the 6F5. A slight difference of voltage adjustment will be needed to correct for the grid biasing of each tube. Otherwise the plate voltage control will not be critical. The advantage of the circuit lies in the fact that the output impedance of the unit is high, which may serve a purpose when the following transducer must not be loaded.

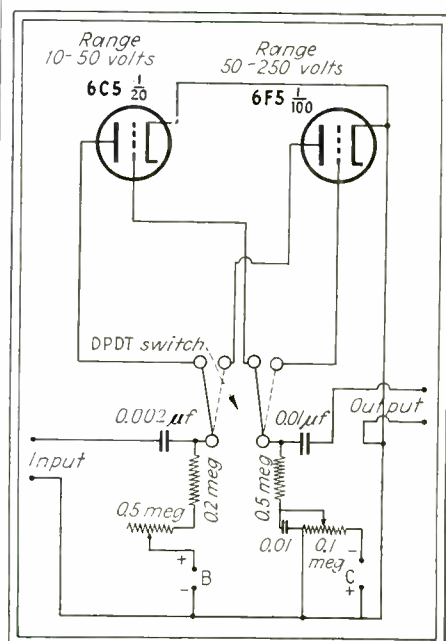

Circuit diagram of the electronic voltage attenuator



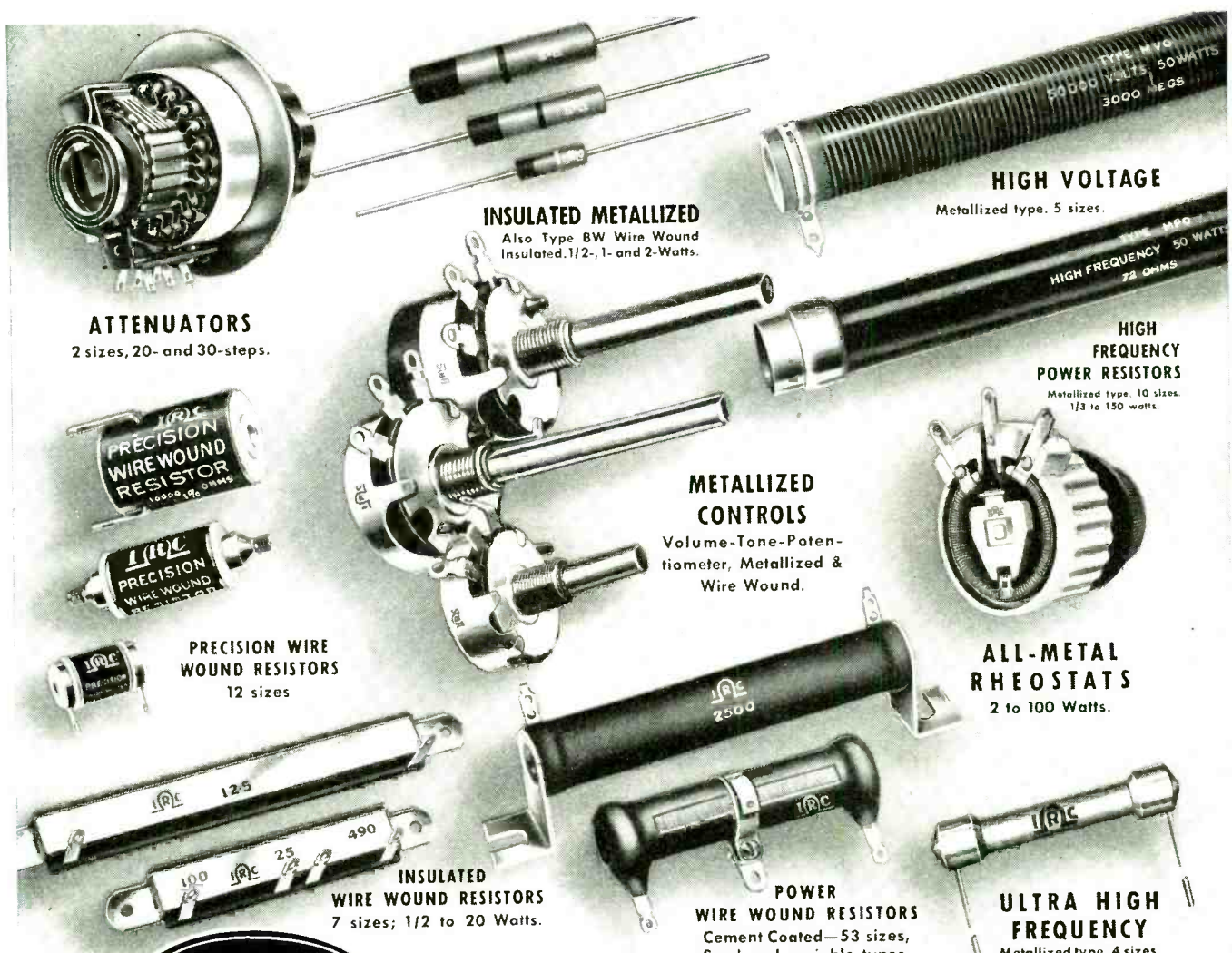

**ATTENUATORS**  
2 sizes, 20- and 30-steps.

**INSULATED METALLIZED**  
Also Type 6W Wire Wound  
Insulated, 1/2-, 1- and 2-Watts.

**HIGH VOLTAGE**  
Metallized type, 5 sizes.

**PRECISION WIRE WOUND RESISTOR**  
10000 1% 0.1W

**PRECISION WIRE WOUND RESISTOR**  
10000 1% 0.1W

**PRECISION WIRE WOUND RESISTORS**  
12 sizes

**METALLIZED CONTROLS**  
Volume-Tone-Poten-  
tiometer, Metallized &  
Wire Wound.

**HIGH FREQUENCY POWER RESISTORS**  
Metallized type, 10 sizes,  
1/3 to 150 watts.

**ALL-METAL RHEOSTATS**  
2 to 100 Watts.

**INSULATED WIRE WOUND RESISTORS**  
7 sizes; 1/2 to 20 Watts.

**POWER WIRE WOUND RESISTORS**  
Cement Coated—53 sizes,  
fixed and variable types.

**ULTRA HIGH FREQUENCY**  
Metallized type, 4 sizes.



# One COMPANY THAT MEETS ALL RESISTANCE NEEDS

With so much depending upon the selection of the one right resistor for any job, the importance of having a single, specialized source of supply for all of the many fixed and variable resistance types becomes plainly evident. You gain full benefit of IRC's many years of experience in supplying the right resistors—in the right shapes—with the right terminals—protected by the right coatings—and selected with a full understanding of the specific problems involved. Above all, you are assured of dependability—the natural result of years of intense specialization on the development and production of quality resistance units only.



Makers of Resistance Units of More Types, in More Shapes, for More Applications Than Any Other Manufacturer in the World. Catalog of any type on request.

**INTERNATIONAL RESISTANCE COMPANY**

403 N. BROAD ST., PHILADELPHIA, PA.



ONLY 1 ounce needle pressure, with 1.4 volts output at 1000 cps (Audiotone record)—over twice the output voltage of any other lightweight pickup cartridge! This means improved performance and longer record life—at low cost! New exclusive design permits accurate production control of uniformity. Designed for permanent point needles. Will directly replace other flat-type cartridges in pickups with pressure of 1 ounce or more. Excellent wide-range response. Sturdy metal case. Genuine Bimorph Crystal. Available in 6 types to fit your requirements—with minimum pressures from 1 ounce to 2 ounces, with outputs as high as 5½ volts. List price, without needle, \$4.00. Write today for full details.



**New "Hi-Lo" Lightweight Crystal Pickups**  
 New Shure Crystal Pickups with "Hi-Lo" Cartridges have the greatest ratio of output voltage to needle point impedance available today. Light weight model practically eliminates record wear—keeps records like new. Offset head. Modern streamlined plastic arm in mahogany finish blends harmoniously with modern radio cabinets. List price, without needle, \$5.50. Other models also available.

**SHURE BROTHERS, 225 West Huron St., Chicago, U. S. A.**  
 Designers and Manufacturers of Microphones, Pickups, Cutters  
 Shure Patents Pending. Licensed under patents of the Brush Development Co.



## Regeneration Improves Receiver Performance

BY WILLARD MOODY  
 Engineering Department, Ansley Mfg. Co.

THE AVERAGE LOW-PRICED RECEIVER as it is made today, has poor selectivity in the mixer stage. This lack of selectivity is caused by a variety of reasons, probably the most important one being the lack of an r-f stage. A great deal of unsatisfactory performance is caused by poor design of the coil. Very often the coil is small, unshielded, and close to the metal chassis.

Designers might well turn their attention to the problem of attaining a high Q in the first tuned circuit. However, the equally important aspect of proper shielding to prevent unwanted noise and interference from high power local stations which is so common in many sets today, should not be overlooked. A means of achieving a high Q

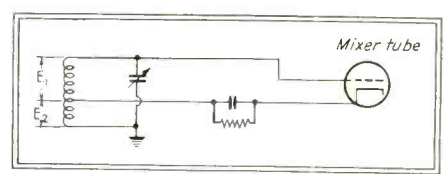

Fig. 1—Circuit which increases the selectivity of the mixer stage

without materially altering the coil circuit is shown in Fig. 1. Here regeneration is used. This has the effect of reducing the effective resistance of the coil and thus increasing Q. Oscillation is prevented by choosing a value of Q that is not too high, and by employing shielding. The Q will be equal to the reactance divided by the resistance, or to the ratio of the voltage  $E_3$  to the voltage  $E_1$ .

The theoretical aspects of this circuit as applied to high frequencies have been discussed in a recent article ("Regeneration in the Preselector", January, 1940 issue of QST). However, so far as the writer is aware, the idea has not been used in the consideration of broadcast receiver design problems. It should be pointed out that the effect is

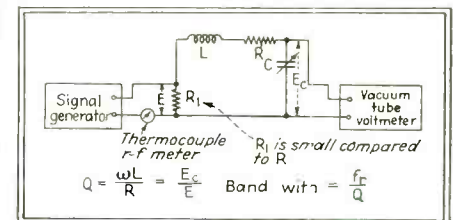
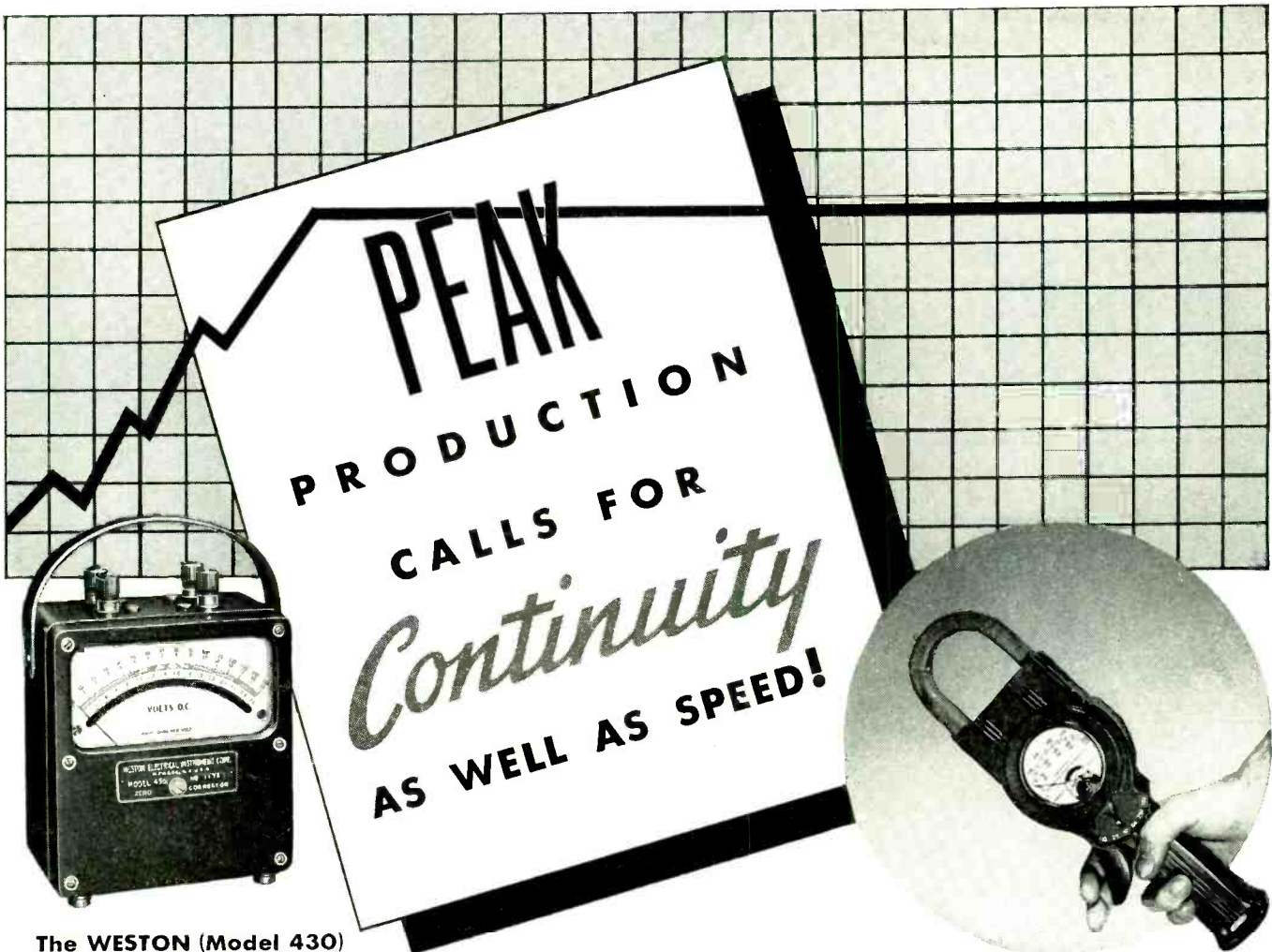

Fig. 2—Circuit for measuring Q

not caused by oscillation, and no beat notes or heterodynes should occur. The effect of regeneration on a tuned circuit has been known for a long time, but it is generally avoided because of instability in broadcast receivers except for a few isolated cases.

A convenient circuit for measuring the Q of a coil is shown in Fig. 2. The figure of merit is obtained by dividing





**The WESTON (Model 430)  
Maintenance Tester**

Built for active maintenance... extremely compact, rugged, and with enduring precision. Extra large openings with hand-calibrated mirror scales insure quick, accurate readings. Available in AC and DC instruments and single phase wattmeters. Inexpensively priced.



**The WESTON (Model 703)  
Foot-Candle Meter**

Measures fluorescent, mercury-vapor, incandescent and all other types of lighting direct... without correction factors. Equipped with the WESTON VISCOR filter... a stable, all-glass filter which corrects for all types of lighting regardless of color composition. Saves time, eliminates errors in testing. Available in models for shop and laboratory requirements.

Here are the tools industry is using to help keep motors and machines constantly in fighting trim; forestalling costly breakdowns and work interruptions, eliminating power losses... and, because of their simplicity, broad utility and dependable accuracy, cut precious hours from the usual testing routine. Weston Electrical Instrument Corporation, 618 Frelinghuysen Ave., Newark, New Jersey.

**The WESTON (Model 633)  
AC Clamp-Ammeter**

Provides the quickest, simplest means for testing electrified equipment regularly... thus insuring efficient, uninterrupted operations. The clamping jaws are simply closed over the conductor or bus-bar, and current reading taken. Circuits are never disturbed... work never interrupted. Has 6 AC current ranges for maintenance needs.

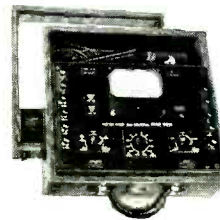

**The WESTON  
(Model 785)  
Industrial  
Circuit Tester**

With 27 carefully selected voltage, current and resistance ranges, Model 785 handles "trouble" in the most efficient, practical manner. With DC voltage sensitivity of 20,000 ohms per volt, it is ideal for testing sensitive relay circuits, signal and telegraphic systems, photocell circuits, alarm systems, etc... also for testing small motors and controls, lighting circuits, etc. Can also be used with current transformers and voltage multipliers.

Laboratory Standards... Precision DC and AC Portables... Instrument Transformers... Sensitive Relays... DC, AC, and Thermo Switchboard and Panel Instruments.

**WESTON**

Specialized Test Equipment... Light Measurement and Control Devices... Exposure Meters... Aircraft Instruments... Electric Tachometers... Dial Thermometers.

# "Solve Platter Matter with 1300A Reproducer Set"

says Chief Engineer

"If present reproducer is member of tribe long extinct... if programs suffer... hunt up Graybar messenger telling tale of Western Electric 1300A Reproducer Set," says Chief Engineer.

"You'll discover it includes the 300A Reproducer Panel... turntable, motor switch, speed change switch, combined impedance matching coil and variable equalizer—four distinct output impedances and 7 reproducing characteristics."

Write for Bulletin T1631: Graybar Electric Co., Graybar Bldg., New York, N. Y.

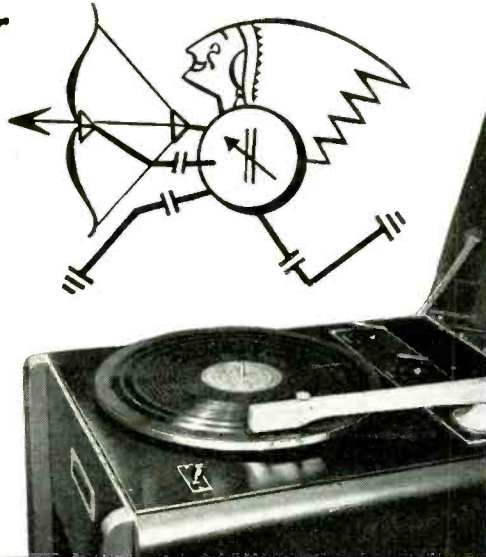

## Western Electric

## SPRAYED-METAL TERMINALS

*Simplify Mounting Problems*

● Sprayed-metal terminals of Brass, Copper and Aluminum, Monel or Nickel, with which GLOBAR Brand Ceramic Resistors are equipped, provide the solution to many special resistor installation problems.

The metal is sprayed in a molten state under high pressure, driving the minute globules into the pores of the resistor surface. This assures a positive electrical contact and makes the use of fuse clips an ideal method of mounting.

This is only one of the many desirable features of GLOBAR Brand Ceramic Resistors. Let us tell you the complete story.

**GLOBAR DIVISION**  
**THE CARBORUNDUM COMPANY**

REG. U. S. PAT. OFF.  
**NIAGARA FALLS, N. Y.**

(Carborundum and Globar are registered trade-marks of and indicate manufacture by The Carborundum Company)

*Globar* CERAMIC RESISTORS

the voltage across the condenser  $C$  by the voltage across the resistance  $R_1$ . These measurements are made at the resonance which is indicated by a maximum deflection on the r-f meter. The  $Q$  of a coil will change with a change in frequency. It is usually measured at the high frequency end of the band covered by the coil because there we encounter the poorest selectivity. The band of frequencies which a coil will pass can be calculated by dividing the frequency to which the coil is tuned by the  $Q$  of the coil at that frequency. Thus a coil having a comparatively high  $Q$  of 100 at 1700 kc has a band width (neglecting external loading due to antenna or tube) of 17 kc. A coil with a  $Q$  of 50 at the same frequency has a bandwidth of 34 kc. If the shielding and metal chassis losses are added, the selectivity is even worse. Obviously, to gain selectivity we must increase the  $Q$  of the coil, at the same time keeping in mind the necessity for adequate shielding to prevent oscillation.

While the ideal approach to the problem would be the incorporation of a bona-fide r-f stage, it is realized that economic reasons may not warrant the additional expense which would have to be added to the purchase cost of a receiver for sale. Regeneration offers a simple way out in such instances.

• • •

## Electronic View-Finder for Television Camera

AN ELECTRONIC VIEW-FINDER which reproduces precisely the scene which is being picked up by the television camera has recently been developed by the Allen B. DuMont Laboratories,



Electronic view-finder with cover removed. Note the special squatty cathode-ray tube employed

Inc, and is now available for use with DuMont television cameras.

The electronic view-finder mounts on the side of the DuMont Iconoscope camera, and uses a high-intensity 5-inch cathode-ray tube which provides a very fine focused brilliant image. Brightness, focus, video gain, hori-



zontal size and vertical size controls are arranged around the face of the tube.

An eyeshield of proper length for correct viewing distance, prevents stray light from interfering with a clear view of the image on the tube screen. Three screwdriver adjustments at the side of the unit provide for horizontal and vertical centering and for vertical linearity. Approximately twice normal horizontal and vertical amplitude are available, so that images can be enlarged or stretched to match the resolution, camera focus and field, for precise view finder and focusing functions. The electronic view finder reproduces the video image as picked up by the camera lens and iconoscope, and as translated into television terms, thereby serving at once as a view finder and focusing means and even as an image monitor at the camera. The cameraman knows precisely what he is picking up, because he can see his own television results, which heretofore has not been the case in video practice.

The electronic view finder connects with its own power-supply unit which supplies all voltages necessary for its operation. This unit also preamplifies the video signal from the camera, and supplies it to the finder unit through a coaxial cable. At the same time, the horizontal and vertical sweep voltages are preamplified in the camera control unit and fed through the camera and through a two-conductor cable to the two-prong receptacle of the view finder.

The electronic view finder makes the television camera a truly video pickup means, for the cameraman now knows precisely what he is getting as he aims his lens at studio or outdoor scene.

• • •

### OSCILLOGRAPHIC STUDY OF AVIATION FUELS

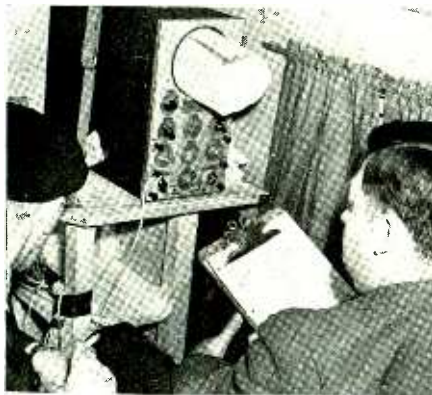

Exhaustive ground and flight tests are made of new aviation fuels. When the planes are in flight, engineers note firing conditions inside the cylinders on the oscilloscope screen. The photograph shows one of these tests being run in a large twin-motor commercial plane



## PACKAGE UNITS

**ELECTRICAL and MECHANICAL UNITS BUILT TO YOUR SPECIFICATIONS FOR SIMPLIFIED ASSEMBLING IN . . . *Your Product***

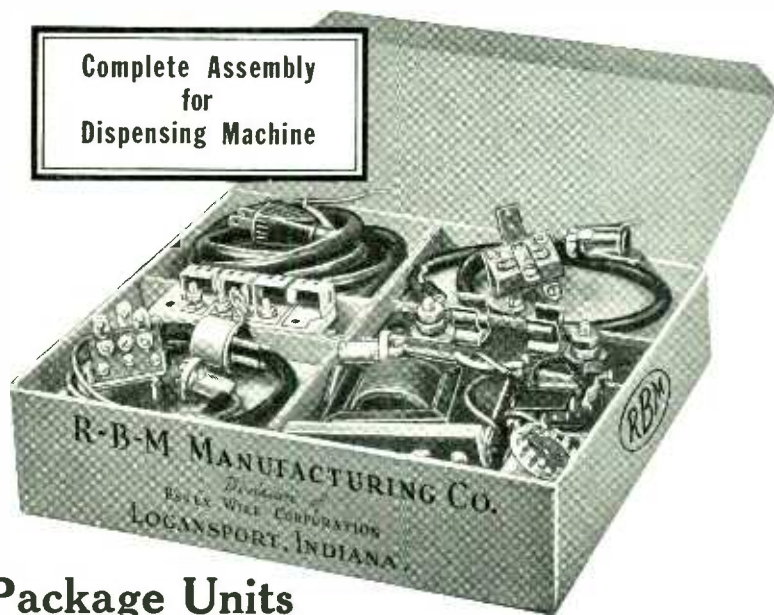

### Package Units

—a new forward step in the electronic, automatic, remote control arts and aviation field—may contain electrical and mechanical devices, mounting brackets, wiring assemblies, cord sets. Complete equipment for automatic operation of counting, weighing and dispensing machines, automatic control of production equipment and general control of electronic circuits are examples.

Executives taking advantage of this plan free their organization from a maze of details, thus saving time, energy and costs. You layout the operating and space requirement—we consult with you and recommend a complete assembly to meet the required performance. All parts necessary for installation are carefully packed in an individual box ready for distribution to the production line.

*Simplified engineering—simplified purchasing—simplified production and production control—undivided responsibility—and real economy are all offered in this new*

*PACKAGE UNIT.*

**R-B-M MANUFACTURING CO.**  
*Division of*  
**ESSEX WIRE CORPORATION**  
**LOGANSPORT, INDIANA**



*Bliley*

A  
C  
C  
U  
R  
A  
T  
E

D  
E  
P  
E  
N  
D  
A  
B  
L  
E



**QUARTZ  
CRYSTALS**

FOR GENERAL COMMUNICATION FREQUENCIES

**BLILEY ELECTRIC COMPANY**  
UNION STATION BUILDING      ERIE, PA.

Bliley Quartz Crystals and Mountings are precision-made for all frequencies between 20Kc. and 30Mc. Catalogue G-12 describes the complete line. Write for your copy.

## Filament Voltage Regulation for X-Ray Tubes

By CARL C. SMITH

THE OUTPUT OF AN X-RAY tube varies as the square of the applied voltage, and the intensity at any voltage is dependent upon the target current. The absorption of the radiation varies with the density of the absorbing medium and approximately as the cube of the target voltage of the tube. At target voltages below about 3000 volts and filament temperatures at which appreciable emission is obtained, the target current is limited by the space charge within the tube and varies as the three-halves power of the target voltage. When the voltage is raised to values at which all the emitted electrons are drawn to the target, the current through the tube is practically independent of the target voltage. Tungsten, of which the filament is composed, exhibits definite temperature-saturation values and when this condition is reached, and at which an x-ray tube is usually operated, the target current varies throughout enormous values with comparatively small filament temperature changes.

Comparatively small voltage changes on the filament can profoundly affect the target current in the tube and thereby the x-ray intensity at any stated target voltage. With filaments of low thermal inertia a rapid change in emission can take place, even at fractional second radiographic exposures, if the filament voltage is poorly regulated, or if the inherent regulation of the equipment transformers is poor. The writer has observed as much as 14 percent change in filament voltage when the target voltage has been applied to the tube during a 3/25 sec. exposure. During the exposure period a rapid change of intensity of the radiation takes place making consistent results difficult to obtain.

If, as is customary, the filament and rectifier transformers are supplied from the same source a voltage variation of the supply will affect both filament and target voltages at a similar rate. The target voltage will have to be doubled, say from 25,000 to 50,000 volts in order to produce the same density on a photographic film as will be obtained with a ratio of target current change of 7.3. A ratio of current change of this value can be obtained with a filament voltage change of roughly 20 percent so that it would seem the change in filament voltage is a determinant in cases where excessive film spoilage is apparently due to poor supply voltage regulation.

However, it has been found that the application of resonant circuit voltage-regulating transformers to supply the filament directly, or to feed the filament transformer, results in definite improvement in obtaining consistent film densities in some of the earlier equipments, particularly where the inherent regulation of the equipment is unsatisfactory.

## NEED RELAYS?

No matter whether your specifications call for jack, target, potential, oil dash pot, thermal time delay or indicator types of relays, you will find all types for all purposes made by Autocall, specialists for over 30 years in signalling and control devices and equipment.

### INDICATOR TYPE

RI-10

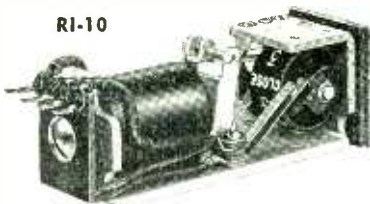

Eleven position rotary indicator. High speed. Indicator can be numbered, lettered or consists of colored bars, etc., as required.

Send for Free Catalog

**The AUTOCALL Co.**  
SHELBY, OHIO

Send for  
**FREE**  
Catalog

AUTOCALL COMPANY  
Shelby, Ohio  
Without obligation, please send me a copy of your new No. R-3 catalog on signalling, control devices and equipment.

Name .....  
Address .....  
City ..... State .....

## New Carter AIRCRAFT TYPE GENEMOTORS

● **TRIPLE OUTPUT!!**—Think what this means—3 separate outputs from a single Dynamotor! The new Carter Triple Output Dynamotor shown below, is winning wide acclaim in the Aircraft Industry because of its high efficiency, small size, and extra light weight.



● Write today for descriptive literature on Carter Dynamotors—D.C. to A.C. Converters—Double and Triple Output Dynamotors—Magmotors—Special Motors—High Frequency Converters—and Permanent Magnet Dynamotors.

**Carter Motor Co.**  
CHICAGO ILLINOIS

1606 Milwaukee Ave.      Cable: Genemotor  
Carter, a well known name in Radio since 1922



## Variable Equalizer

(Continued from page 29)

tic which affords a satisfactory compromise between fidelity and signal-to-noise ratio for shellac phonograph records is shown in Fig. 8. Shellac or filled pressings reproduced at 33 1/3, rather than 78 rpm., should employ a somewhat narrower acceptance band because the noise spectrum is shifted to a lower frequency range. This explains why transcriptions pressed in filled abrasive materials are unsatisfactory on high fidelity systems.

The photographs of the post-distorter reveal the general type of construction employed and that the unit was designed for rack mounting. The tubes are available through a front panel access grill. The bass-compensation and high frequency attenuation controls are brought out for front panel operation because their settings determine the characteristics of the unit. The amplifier gain control is accessible in the tube well. This is seldom adjusted after an initial setting is made for a given reproducer. Two push buttons associated with the respective filter controls permit complete disconnection of the filter networks, the insertion loss remaining constant. This arrangement adds flexibility to the unit by permitting either or both networks to be removed from the circuit. With both buttons operated, the unit may be used as a high-fidelity amplifier for microphone or similar service. When the unit is serving its normal post-distortion function, operation of the buttons affords a convincing demonstration of the functions of the individual networks, and of the effectiveness of the entire unit.

Operated with suitable reproducer, it permits the utmost in available fidelity to be obtained on phonograph records (consistent with the relatively high surface-noise and excessive recorded levels), as well as from the finest lateral and hill-and-dale transcriptions pressed in vinylite. It enables the engineer to equalize his reproduction system from the recording characteristic calibration records now available from some transcription companies.

# New

## DECADE AMPLIFIER

### MODEL 220



MODEL 300  
ELECTRONIC  
VOLTMETER

MODEL 220  
DECADE AMPLIFIER

**NEW ACCESSORY FOR MODEL 300 VOLTMETER  
FOR MEASUREMENT OF VERY LOW A-C VOLTAGES**

**Decade Amplifier:** This is a highly stable amplifier giving accurately standardized gains of 10x or 100x over a frequency range of 10 to 100,000 cycles. Operated by self-contained batteries having a life of over 150 hours. Used with our Model 300 Electronic Voltmeter (as shown in cut) A-C voltages down to 0.00003 volt (30 microvolts) can be measured. By means of special circuits the gain is independent within 2% of circuit constants, battery voltages and tubes. Fully described in Bulletin 7.

**Electronic Voltmeter:** A popular instrument for the measurement of A-C voltages, 10 to 150,000 cycles, 1 millivolt to 100 volts (up to 1000 and 10,000 volts with Model 402 Multipliers). Logarithmic voltage scale and auxiliary uniform decibel scale. A-C operated. By means of special circuits indications are independent of line-voltage, tubes and circuit constants within 3% over entire frequency range. Several accessories, such as an artificial ear, vibration pickup and multipliers are available. Fully described in Bulletin 6.

MADE BY

## Ballantine Laboratories, Inc.

BOONTON, NEW JERSEY

ELECTRICAL AND ACOUSTICAL INSTRUMENTS

# VERSATILE POWER SUPPLY for AIRCRAFT

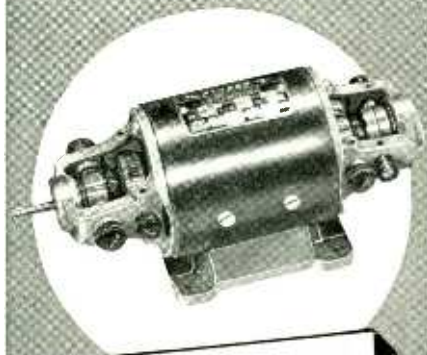

## PINCOR Double Input Double Output DYNAMOTORS

Pincor Dual Voltage... double input and double output... dynamotor is further proof of Pincor leadership in today's fast moving developments in aircraft and other vital radio equipment. One unit for both receiving and transmitting... saving cost as well as precious space and weight. Available in a multitude of voltage combinations and ratings. Consult our engineers. Send for free NEW Pincor Dynamotor Catalog.

**PIONEER GEN-E-MOTOR**  
CHICAGO, ILLINOIS  
Export Address: 25 Warren St., N. Y., N. Y.  
Cable: SIMONTRICE, New York



**A  
NEW  
CATALOG  
FOR YOU!**

Pioneer Gen-E-Motor  
Dept. R-4G, 5841 Dickens Ave., Chicago, Ill.

Please send me NEW PINCOR DYNAMOTOR  
CATALOG at once!

NAME \_\_\_\_\_

ADDRESS \_\_\_\_\_

CITY \_\_\_\_\_ STATE \_\_\_\_\_

# TUBES

Characteristics of phototubes are presented in addition to the data on receiving tubes registered by the R.M.A. Data Bureau during May

## Tube Registry

THE R.M.A. Committee on Vacuum Tubes has declared the following tubes to be inactive: 1B4T, 1E5G-T, 2A3H, 2B6, 6D5, 6D5G, 6D5MG, 6S6GT, 25D8GT, 25Z3, and all MG types. The same R.M.A. committee has also designated that certain types of the G and GT series shall be combined in one type number. The combined type numbers are: 3Q5GT/G, 6AC5GT/G, 6AE5GT/G, 6N7GT/G, 6SQ7GT/G, 12SQ7GT/G, 25A6GT/G, 25A7GT/G, 25AC5GT/G, 25L6GT/G, 25Z6GT/G, 35L6GT/G, 35Z5GT/G, 50Y6GT/G, 117Z6GT/G, 6H6GT/6H6G, and 6P5GT/6P5G.

Tube Types registered by R.M.A.  
Data Bureau During May 1941

## Type 12H6 (M)

DOUBLE diode, heater type, MT-8 metal envelope, seated height 1 3/16 inches (max), 7-pin octal base.

### RATINGS

$E_b = 12.6$  v  
 $I_a = 0.15$  amp  
 $E_b = 150$  v (max) per plate  
 $I_b = 8$  ma (max)  
 $C(p_1 - p_2) = 0.10$   $\mu$ f (max)  
 $C_{p1} - (h + k_1 + \text{shell}) = 3.0$   $\mu$ f  
 $C_{p2} - (h + k_2 + \text{shell}) = 3.4$   $\mu$ f  
Basing 7Q-1-1

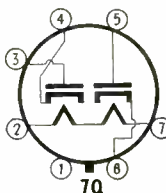

## Type 7S7 (GL)

TRIODE-HEXODE converter, remote cutoff, heater type, T-9 integral glass envelope-base, seated height 2 1/4 inches (max), 8-pin lock-in base.

### TYPICAL OPERATION

$E_b = 6.3$  v  
 $I_a = 0.30$  amp  
 $E_b(\text{hexode}) = 250$  v  
 $E_b(\text{triode}) = 250$  v  
 $E_{c2A} = 100$  v  
Triode Grid Resistor = 50,000 ohms  
 $r_p(\text{hexode}) = 2$  megohms (approx)  
 $I_c(\text{triode}) = 0.4$  ma  
 $I_b(\text{hexode}) = 1.7$  ma  
 $I_b(\text{triode}) = 5.0$  ma  
 $E_{c2A} = 2.2$  ma  
Total Cathode Current = 9.3 ma  
 $\rho_c(\text{hexode}, E_{c3} = -2$  v) = 600  $\mu$ hos  
 $\rho_c(\text{hexode}, E_{c3} = -21$  v) = 2  $\mu$ hos

### TRIODE SECTION ONLY

$E_b = 6.3$  v  
 $E_b = 100$  v (max)  
 $E_c = 0$  v  
 $I_b = 7.0$  ma  
 $r_p = 10,500$  ohms  
 $\rho_m = 1700$   $\mu$ hos

### DIRECT INTERELECTRODE CAPACITANCES

Hexode Grid 1 to Hexode Plate = 0.04  $\mu$ f  
Hexode Grid 1 to Triode Plate = 0.10  $\mu$ f  
Hexode Grid 1 to Triode Grid 1 and Hexode Grid 3 = 0.35  $\mu$ f  
Triode Grid 1 to Triode Plate = 1.0  $\mu$ f  
Signal Input = 5.5  $\mu$ f  
Oscillator Output = 3.5  $\mu$ f  
Oscillator Input = 6.0  $\mu$ f  
Mixer Output = 9.0  $\mu$ f  
Basing 8AR-L-7

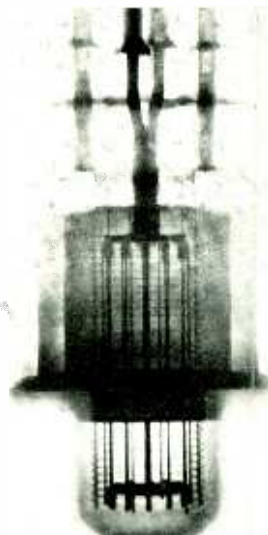
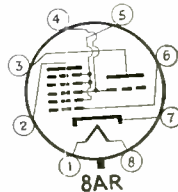

Exterior and x-ray views of the General Electric type GL-880 phototube. Alignment of the internal structure can be checked by the use of x-rays



## Phototubes

### Type PJ-22

General Electric

VACUUM phototube, caesium cathode, window area 0.9 square inch, seated height to center line of cathode 2 3/16 inches, overall length 4 1/2 inches (max), overall diameter 1.165 inch (max), 4-pin base.

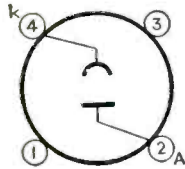
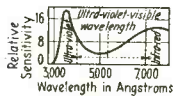

Sensitivity (anode voltage = 90 v) = 14  $\mu$ a/lumen  
 C(cathode-anode) = 2.5  $\mu$ mf  
 Max Ambient Temp = 50° C  
 Max Anode Supply Voltage (dc or peak ac) = 200 v  
 Max Anode Current = 20  $\mu$ a

### Type PJ-23

General Electric

GAS phototube, caesium cathode, window area 0.9 square inch, seated height to center line of cathode 2 3/16 inches, overall length 4 1/2 inches (max), overall diameter 1.165 inch (max), 4-pin base.

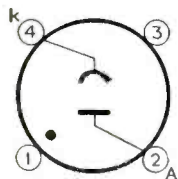
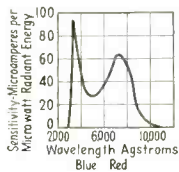

Sensitivity (anode voltage = 90 v) = 50  $\mu$ a/lumen  
 C(cathode-anode) = 2.5  $\mu$ mf  
 Max Ambient Temp = 50° C  
 Max Anode Supply Voltage (dc or peak ac) = 90 v  
 Max Anode Current = 20  $\mu$ a

### Type FJ-401

General Electric

GAS phototube, rubidium cathode, window area 0.9 square inch, seated height to center line of cathode 2 3/16 inches, overall length 4 1/2 inches (max), overall diameter 1.165 inch, 4-pin base.

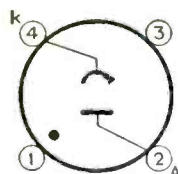
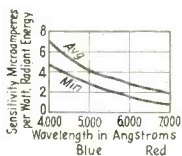

Sensitivity (4000 A.) = 7 ma/watt  
 C(cathode-anode) = 2.5  $\mu$ mf  
 Max Ambient Temp = 50° C  
 Max Anode Supply Voltage (dc or peak ac) = 90 v  
 Max Anode Current = 10  $\mu$ a

# PLASTIC SHAFT

COMBINES 8 PARTS AND FUNCTIONS  
IN SINGLE PIECE OF MATERIAL

**O**NE of General Electric's five top award winners in the recent Modern Plastics Competition was a molded Textolite contactor shaft which incorporates the following 8 parts and functions in a single piece of material:

1. Bearings on which to rotate an assembly of parts.
2. Support for magnet armature.
3. Individual bearing, stop, guides and barriers for each of five contact tips.
4. Guides and barriers for each of five flexible braid connectors.
5. Spring seats for each of five movable contact tips.
6. Molded arms with which to operate up to seven auxiliary switches that may be used in the final application.
7. Molded arms with which to operate mechanical interlocks.
8. Complete high quality insulation for all of the above parts.

Because the shaft is a single piece of material, the possibility of loosening of parts is eliminated, making for permanent maintenance of factory adjustment and long life. Because the material is in itself high quality insulation, it permits the closest possible spacing of the parts that must be alive, such as contact fingers, terminals and connectors. The Textolite material also adds to the life of the main bearings, and makes them free from corrosion or lubrication troubles.

For a free copy of our new booklet, "One Plastics Avenue," write Section H-15, Plastics Department, General Electric Co., One Plastics Avenue, Pittsfield, Mass. PD-171

**PLASTICS DEPARTMENT**

## GENERAL ELECTRIC

# STABILIZED A. C. VOLTAGE UP TO 25 KVA

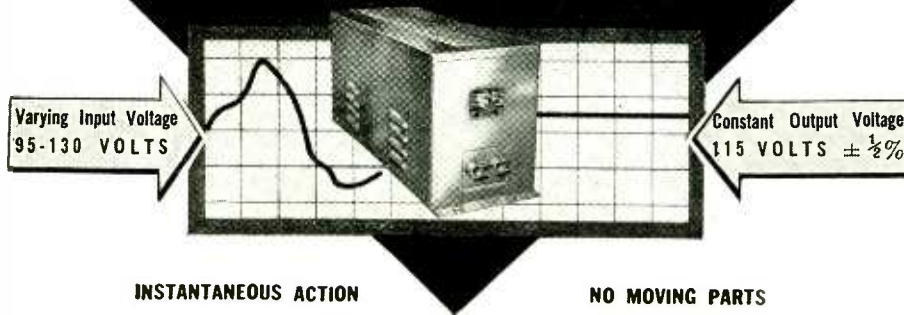

When a precision electrical device or a critical process is powered from an AC line, a Raytheon Voltage Stabilizer will permanently eliminate all of the detrimental effects caused by AC line voltage fluctuations. Made for all commercial voltages and frequencies, single or three phase.

Raytheon's twelve years of experience in successfully applying the Stabilizer to hundreds of perplexing voltage fluctuation problems is at your service. It will pay you to take advantage of our engineering skill.

Write for Bulletin DL48-71 JE describing Raytheon Stabilizers.

**RAYTHEON MANUFACTURING CO.**  
100 Willow Street, WALTHAM, Massachusetts



DC VOLTS . . . 0-2.5-10-50-250-1000-5000 at 10,000 Ohms per Volt.  
AC VOLTS . . . 0-2.5-10-50-250-1000-5000 at 1,000 Ohms per Volt.  
DIRECT CURRENT 0-100 Microamperes; 0-1-10-100 Milliampers; 0-1-10 Amperes.  
RESISTANCE . . . 0-400 Ohms (shunt type circuit); 0-40,000 Ohms and 0-4 Megohms (series type circuit). Self-contained batteries for all resistance ranges. Model 625-T, Complete with All Accessories . . .  
Dealer Net . . . . . \$22.00

**THE TRIPLET ELECTRICAL INSTRUMENT CO.**  
Bluffton, Ohio

**New**  
**WIDE RANGE**  
**PORTABLE**  
**VOLT-OHM-**  
**AMMETER**



**MODEL 625-T**  
Dealer Net . . . . . \$22.00

Complete insulation for high voltage testing . . . RED • DOT Lifetime Guaranteed Instrument . . . Cartridge-Loading Battery Compartment . . . Knob Operated Zero Adjustment for Ohms Ranges.

Model 1280 Kilovolt Tester—for Television and High Voltage . . . AC and DC Volts 0-2500 and 0-10,000, 25,000 ohms per volt DC; 5,000 ohms per volt AC. DC Microamperes 0-50; 0-500; 0-5,000.  
Dealer Net . . . . . \$34.67  
Write for Catalog—  
Section 237 Harman Ave.



## Type FJ-405

General Electric

VACUUM phototube, sodium cathode, window area 0.75 square inch (1-inch diameter), seated height to center line of cathode 2 3/4 inches, overall length 5 inches (max), overall diameter 1 1/2 inch (max), 4-pin base.

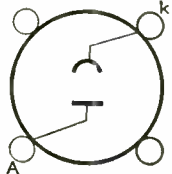
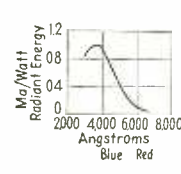

Sensitivity (tube 25 inches from quartz Uviarc Burner operating at 320 watts) = 12  $\mu$ a  
C(cathode-anode) = 5.0  $\mu$ f  
Max Ambient Temp = 50° C  
Max Anode Supply Voltage (dc or peak ac) = 200 v  
Max Anode Current = 50  $\mu$ a

## Type SR-50

Westinghouse

VACUUM phototube, aperture 13/16 inch x 1 3/8 inch, seated height to center line of cathode 2 1/2 inches, overall length 4 9/16 inches (max), overall diameter 1 7/16 inches (max), 4-pin base.

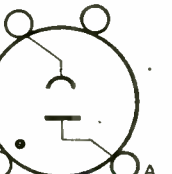
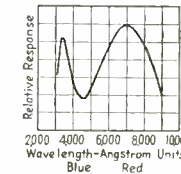

Luminous Sensitivity = 15.0  $\mu$ a/lumen  
Maximum Operating Voltage = 500 v  
Max Current = 20  $\mu$ a/sq inch

## Type SR-53

Westinghouse

VACUUM phototube, aperture 13/16 inch x 1 3/8 inch, seated height to center line of cathode 2 1/2 inches, overall length 4 9/16 inches (max), overall diameter 1 7/16 inch (max), 4-pin base.

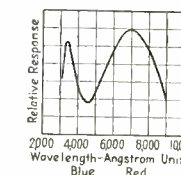

Luminous Sensitivity = 25.0  $\mu$ a/lumen  
Max Operating Voltage = 500 v  
Max Current = 20  $\mu$ a/sq inch



## Type 868

R.C.A.

GAS phototube, caesium coated cathode, window area 1 square inch, seated height to center line of cathode  $2\frac{3}{8}$  inches, overall length  $4\frac{1}{2}$  inches (max), overall diameter 1.165 inch (max), 4-pin base.

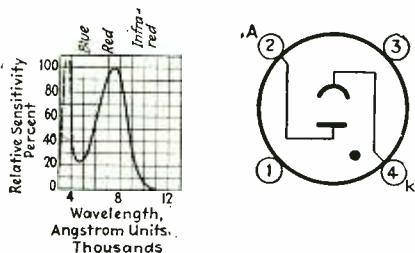

Gas Amplification Factor — Not over 7

Luminous Sensitivity  
 0 cps (dc) = 65  $\mu$ a/lumen  
 1000 cps = 61  
 5000 cps = 57  
 $C$ (cathode-anode) = 2.5  $\mu$ f  
 Max Ambient Temp = 100° C  
 Max Anode Supply Voltage (dc or peak ac) = 90 v  
 Max Anode Current = 20  $\mu$ a  
 Sensitivity ( $E$  anode supply = 90 v and  $R_i$  = 1 megohm) = 0.0050  $\mu$ a/ $\mu$ watt radiant flux at 7500 Å. See curve.

## Type 917

R.C.A.

VACUUM phototube, caesium coated cathode, window area 1 square inch, seated height to center line of cathode  $2\frac{3}{8}$  inches, overall length  $4\frac{7}{16}$  inches (max), overall diameter 1.165 inch (max), 4-pin base.

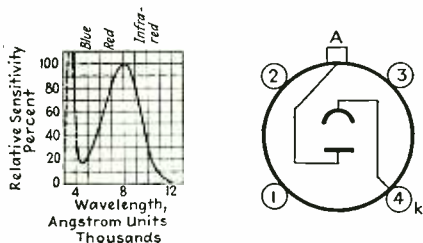

Luminous Sensitivity  
 0 cps (dc) = 20  $\mu$ a/lumen  
 1000 cps = 20  
 5000 cps = 20  
 $C$ (cathode-anode) = 2.0  $\mu$ f  
 Max Ambient Temp = 100° C  
 Max Anode Supply Voltage (dc or peak ac) = 500 v  
 Max Anode Current 30  $\mu$ a  
 Sensitivity = 0.0020  $\mu$ a/ $\mu$ watt radiant flux at 8000 Å. See curve.

## Type 918

R.C.A.

GAS phototube, caesium coated cathode, window area 1 square inch, seated height to center line of cathode  $2\frac{3}{8}$  inches, overall length  $4\frac{1}{2}$  inches (max), overall diameter 1.165 inch (max), 4-pin base.

# Look to Lingo

... for PEAK PERFORMANCE  
 ... for LOW MAINTENANCE COST  
 ... for INSURED STABILITY

AM  
 VERTICAL  
 RADIATORS

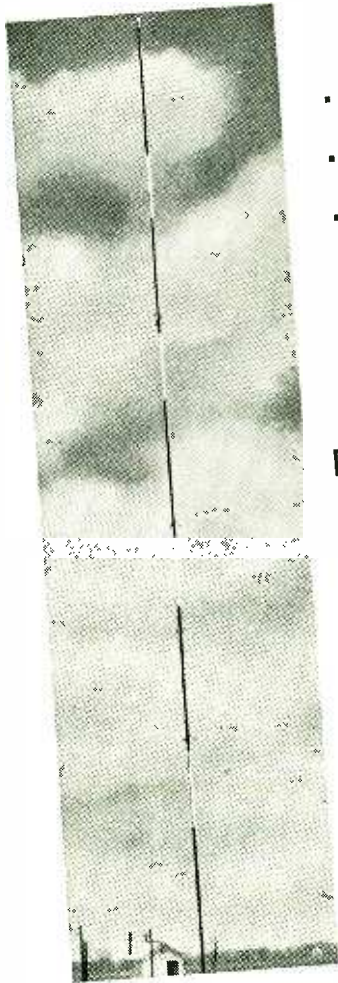

In planning your new specifications be sure to investigate the Lingo Tubular Steel Radiator. Alert engineers throughout the country are enjoying performance that far exceeds their expectations. Lingo Radiators are constructed of seamless copper-bearing steel tubing of uniform and narrow cross-section throughout, providing low base capacitance; high characteristic impedance; practically sinusoidal current distribution, and other important features to assure you of trouble-free peak performance.

FM  
 TURNSTILE  
 RADIATORS

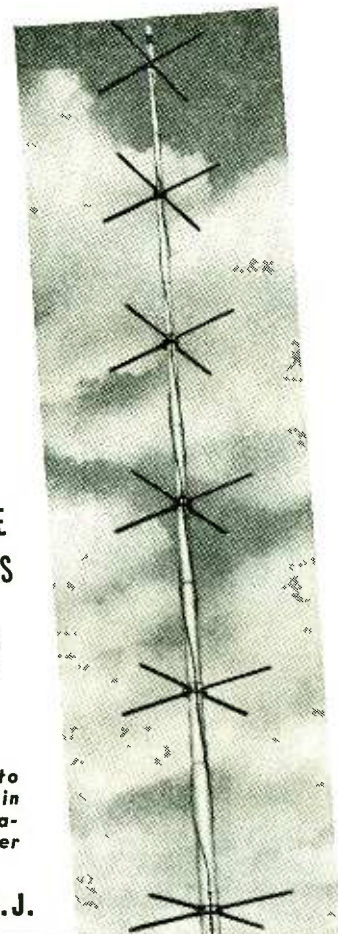

The proven antenna for this new field! The Lingo Turnstile FM Antenna is the first and only antenna of its kind. The new, patented design is the result of years of research and development and is now available for installation. Quotations will be gladly offered and include essential steel mounting pole, turnstile elements, coupling equipment, transmission lines feeding the elements, etc. Climbing steps, lighting equipment and sleet melting units are also available as optional equipment.

★ Our engineering staff will be pleased to supply you with technical data as it applies in your own case, for either AM or FM installations. In writing please give location, power and frequency of station.

JOHN E. LINGO & SON, Inc., Dept. E-7, Camden, N. J.

**LINGO** VERTICAL  
 TUBULAR STEEL  
 RADIATORS

To Serve Well the  
Professional Radioman

# CREI Puts *FACTS* INTO WORDS



8 Complete Laboratories and Modern Equipment of the CREI RESIDENCE SCHOOL Are Used to Prove and Improve Each Lesson Included in the CREI Home Study Course. . . .

A total of 2700 sq. ft. is devoted to these laboratories:

- MAIN EXPERIMENTAL LABORATORY
- STANDARD FREQUENCY LABORATORY
- TRANSMITTER LABORATORY
- SHOP PRACTICE AND WIRING LABORATORY
- BROADCAST LABORATORY AND STUDIO GROUP
- TELEVISION LABORATORY
- GENERATOR AND POWER LABORATORY
- ADVANCED EXPERIMENTAL AND AUDIO LAB.

What do these extensive Residence School facilities mean to the Home Study student?

They mean that lessons are not only based on theory, but also on practicability and useability as determined by tests made upon the Residence School Class of Students.

They mean that faculty members are constantly applying new theories and putting TECHNICAL FACTS INTO UNDERSTANDABLE WORDS!

They mean that this Residence School background protects and increases each investment in CREI training by providing up-to-date lesson texts developed in our laboratories—keeping pace at all times with the forward surge of the industry.

They mean that based on this scientific foundation CREI offers the only high-type course of its kind in advanced Practical Radio Engineering.

These facts are important to you . . . and to EVERY MAN who is seeking a way to improve his position in the radio field. Write us today for our booklet and pertinent facts as they apply in your own case. Please state briefly your education, radio experience and present position.

"Since 1927"

## CAPITOL RADIO ENGINEERING INSTITUTE

E. H. Rietzke, President

Dept. E-7, 3224-16th St., N.W.  
Washington, D. C.

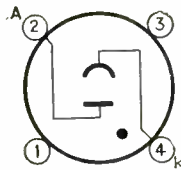
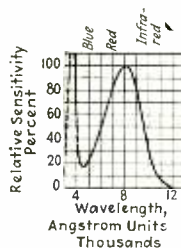

Gas Amplification Factor — Not over 10

Luminous Sensitivity  
0 cps (dc) = 110  $\mu$ a/lumen  
1000 cps = 104  
5000 cps = 96

C (cathode-anode) = 2.5  $\mu$ mf  
Max Ambient Temp = 100° C  
Max Anode Supply Voltage (dc or peak ac) = 90 v  
Max Anode Current = 20  $\mu$ a  
Sensitivity (E anode supply = 90 v and  $R_1$  = 1 megohm) = 0.0100  $\mu$ a/ $\mu$ watt radiant flux at 8000 A. See curve.

### Type SK-60

Westinghouse

GAS phototube, aperture 13/16 inch x 1 3/8 inch, seated height to center line of cathode 2 1/2 inches, overall length 4 9/16 inches (max), overall diameter 1 7/16 inch (max), 4-pin base.

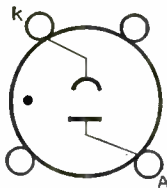
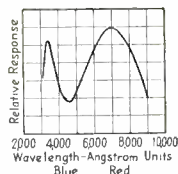

Luminous Sensitivity = 60  $\mu$ a/lumen  
Max Operating Voltage = 90 v  
Max Current = 20  $\mu$ a/sq inch

### Type SK-63

Westinghouse

GAS phototube, aperture 13/16 inch x 1 3/8 inch, seated height to center line of cathode 2 1/2 inches, overall length 4 9/16 inches (max), overall diameter 1 7/16 inch (max), 4-pin base.

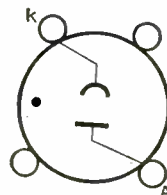
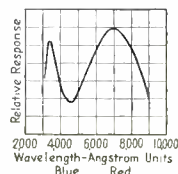

Sensitivity = 125  $\mu$ a/lumen  
Max Operating Voltage = 90v  
Max Current = 20  $\mu$ a/sq inch

## FUSE POSTS

FOR SMALL FUSE APPLICATIONS AND INSTRUMENTS

Let LITTELFUSE Help You Select the Right One

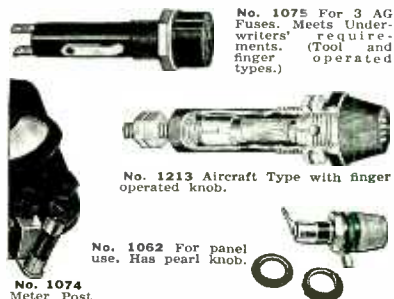

ALL the durable elements you need in a fuse post can be had in one of the many types manufactured by LITTELFUSE. (Only a few of the dozens made by Littelfuse are shown here.) Better products, more customer satisfaction, more sales, less production troubles follow. Many types standard and stocked, specials designed. Write, outlining requirements. Chances are Littelfuse has already made a fuse post that would meet them—and send for catalog.

**LITTELFUSE INC.**  
4755 RAVENSWOOD AVE. CHICAGO, ILL.

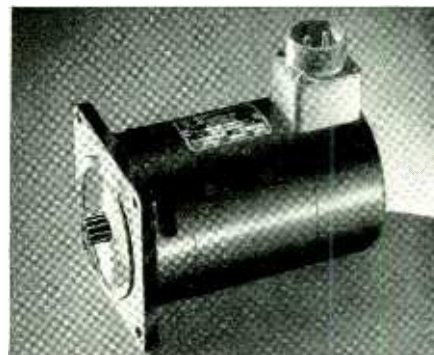

## MORE HORSEPOWER PER POUND!

This new Eicor Lightweight D.C. Motor is another example of Eicor ability to meet today's most exacting requirements. Engineered for special aircraft duty where small size, light weight and high efficiency are essential. Eicor Units have proved themselves under critical operating conditions, in all kinds of service. Let Eicor Engineers help you. Write today.

EICOR, 1050 W. Adams St., Chicago, U.S.A.  
Export: Ad. Auriema, 89 Broad St., N. Y.



July 1941 — ELECTRONICS



## Type 919

R.C.A.

VACUUM phototube, caesium coated cathode, window area 1 square inch, seated height to center line of cathode  $2\frac{1}{2}$  inches, overall length  $4\frac{7}{16}$  inches, overall diameter 1.165 inches, 4-pin base with cathode cap.

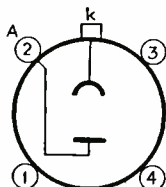
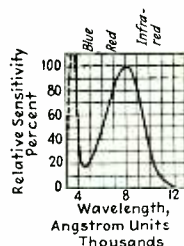

Luminous Sensitivity  
 0 cps (dc) =  $20\ \mu\text{a/lumen}$   
 1000 cps = 20  
 5000 cps = 20  
 $C(\text{cathode-anode}) = 2.0\ \mu\text{f}$   
 Max Ambient Temp =  $100^\circ\text{C}$   
 Max Anode Supply Voltage  
 (dc or peak ac) = 500 v  
 Max Anode Current =  $30\ \mu\text{a}$   
 Sensitivity =  $0.0020\ \mu\text{a}/\mu\text{watt}$   
 radiant flux at 8000 A. See curve.

## Type 920

R.C.A.

TWIN gas phototube, caesium coated cathode, window area 0.3 square inch, seated height to center line of cathode  $2\frac{1}{2}$  inches, overall length 4 inches (max), overall diameter 1.165 inch (max), 4-pin base.

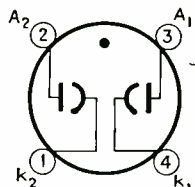
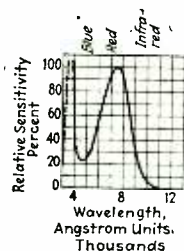

Gas Amplification Factor — Not over 10

Luminous Sensitivity  
 0 cps (dc) =  $75\ \mu\text{a/lumen}$   
 1000 cps = 70  
 5000 cps = 65  
 $C(\text{cathode-anode}) = 1.5\ \mu\text{f}$   
 (each unit)  
 $C(\text{between cathodes}) = 1.6\ \mu\text{f}$   
 $C(\text{between anodes}) = 0.36\ \mu\text{f}$   
 Max Ambient Temp =  $100^\circ\text{C}$   
 Max Anode Supply Voltage  
 (dc or peak ac) = 90 v  
 Max Anode Current =  $10\ \mu\text{a}$   
 Sensitivity ( $I_s$  anode supply  
 = 90 v and  $R_L = 1\ \text{megohm}$ )  
 =  $0.0065\ \mu\text{a}/\mu\text{watt}$  radiant  
 flux at 7500 A. See curve.

## Type 921

R.C.A.

GAS phototube, cartridge type, caesium coated cathode, window area 0.4 square inch, distance from base of cathode cap to center line of cathode  $11/16$  inch, overall length  $1\frac{21}{32}$  inch, overall diameter 0.890 inch (max).



## STACKPOLE SUB-CONTRACTING

*can step up your production  
and solve problems concerning*

## DEFENSE CONTRACTS

★ We are ready and prepared to lend a helping hand to help solve your production problems on defense contracts. We are amply fortified with engineers, craftsmen and equipment to design and produce small parts and sub-assemblies for motors, instruments, etc. Because of our long experience and knowledge of the radio and electrical fields, Stackpole engineers can solve your problems and save you time and money. *Consult with us on your particular problem . . . without obligation, of course!*

Complete Facilities for DESIGNING,  
DEVELOPING, PRODUCING,  
and ASSEMBLING

Small Parts and Sub-Assemblies

including:

- FIXED RESISTORS
- TOGGLE SWITCHES
- ROTARY INDEX SWITCHES
- VARIABLE RESISTORS
- SLIDE OPERATED SWITCHES
- POWDERED IRON CORES



**STACKPOLE CARBON CO.**  
ST. MARYS, PENNA. U. S. A.

# AUTELCO JR. RELAYS

From Every Angle—  
Quality at Low Cost

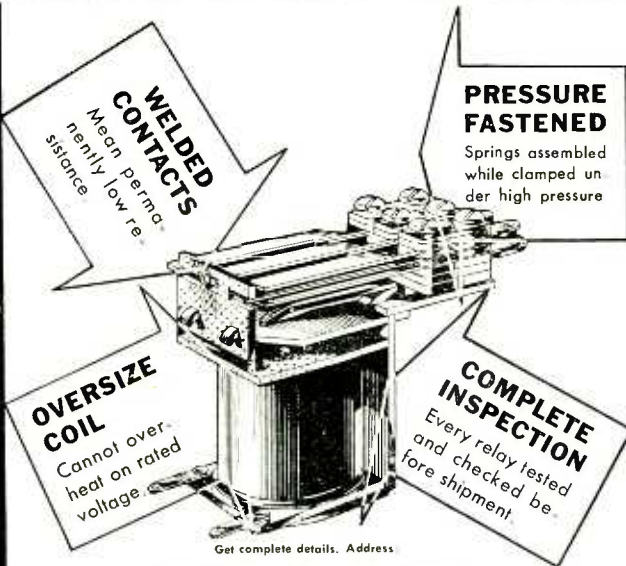

Get complete details. Address  
**American Automatic Electric Sales Company**  
 1033 West Van Buren Street Chicago  
 In Canada: Canadian Telephones & Supplies Limited, Toronto

## AUTOMATIC ELECTRIC

RELAY MAKERS SINCE 1898



### FAMOUS

for years . . .

for their uniform accuracy and great strength . . . for the unique self-locking feature on the "Unbrako" Hollow Set Screw with the Knurled Points . . . for the Socket Head Cap Screw with the Knurled Head that gears right to the fingers and saves assembling time.

"Unbrako" Products are available in a complete range of sizes from number 4 up. For free samples and literature, write today.



REG. U. S. PAT. OFFICE

**SCREW PRODUCTS**

**STANDARD PRESSED STEEL CO.**  
 Box 596, JENKINTOWN, PENNA.

**THE CATHODE RAY TUBE AT WORK**  
 by John F. Rider

In indispensable for its complete, practical information on the Cathode Ray Tube and its use in the Oscilloscope. Explains wave forms and their uses. This 338 page book is pretiously illustrated with 460 plates—illustrated with accepted authority on the subject. Now in its 7th printing. Price \$2.50.

## Approved RIDER BOOKS ON TIMELY SUBJECTS!

**VACUUM-TUBE VOLTMETERS**  
 179 pages—113 illustrations—\$1.50

CHAPTER HEADS: I—Fundamentals of V-T Voltmeters II—Diode V-T Voltmeters III—Triode V-T Voltmeters IV—Slide-Back V-T Voltmeters V—Rectifier-Amplifier V-T Voltmeters VI—Tuned V-T Voltmeters VII—A F and Logarithmic V-T Voltmeters VIII—Measuring D-C Voltage, Current and Resistance IX—Design and Construction X—Calibration and Testing XI—Applications of the V-T Voltmeter Commercial V-T Voltmeters, Bibliography.



**JOHN F. RIDER Publisher, Inc.**  
 404 FOURTH AVENUE, NEW YORK CITY  
 Export Division: Rocke-International Elec. Corp., 100 Varick St., N. Y. C. Cable ARCAD

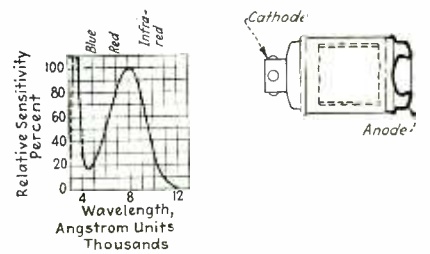

Gas Amplification Factor — Not over 9

Luminous Sensitivity  
 0 cps (dc) = 100  $\mu$ a/lumen  
 1000 cps = 94  
 5000 cps = 87

C(cathode-anode) 1.0  $\mu$ f  
 Max Ambient Temp = 100° C  
 Max Anode Supply Voltage (dc or peak ac) = 90 v  
 Max Anode Current = 20  $\mu$ a  
 Sensitivity (E anode supply = 90 v and  $R_L$  = 1 megohm) = 0.0090  $\mu$ a/ $\mu$ watt radiant flux at 8000 A. See curve.

### Type WL-734

Westinghouse

VACUUM phototube, aperture 13/16 inch x 1 3/8 inch, seated height to center line of cathode 2 7/32 inches, overall length 4 1/8 inches (max), overall diameter 1 5/32 inch (max), 4-pin base.

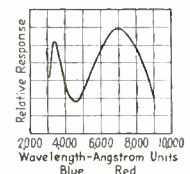

Sensitivity = 15.0  $\mu$ a/lumen  
 Max Operating Voltage = 500 v  
 Max Current = 20  $\mu$ a/sq inch

### Type WL-735

Westinghouse

GAS phototube, aperture 13/16 inch x 1 3/8 inch, seated height to center line of cathode 2 7/32 inches, overall length 4 1/8 inches, overall diameter 1 5/32 inch, 4-pin base.

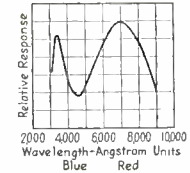

Sensitivity = 60.0  $\mu$ a/lumen  
 Max Operating Voltage = 90 v  
 Max Current = 20  $\mu$ a/sq inch

### Type 925

R.C.A.

VACUUM phototube, window area 0.4 square inch, seated height to center line of cathode 1 1/8 inch, overall length 2 5/8 inches (max), overall diameter 1.275 inches (max), 5-pin octal base.



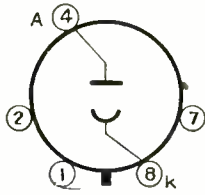
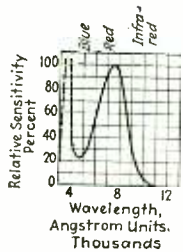

**Luminous Sensitivity**  
 0 cps (dc) = 15  $\mu\text{a/lumen}$   
 1000 cps = 15  
 5000 cps = 15  
**C(cathode-anode) = 1.0  $\mu\text{f}$**   
 Max Ambient Temp = 100° C  
 Max Anode Supply Voltage = 250 v  
 Max Anode Current = 20  $\mu\text{a}$   
 Sensitivity = 0.0015  $\mu\text{a}/\mu\text{watt}$   
 radiant flux at 7500 A. See curve.

### Type 922

R.C.A.

VACUUM phototube, cartridge type, caesium coated cathode, window area 0.4 square inch, distance from base of cathode cap to center line of cathode 11/16 inch, overall 1 21/32 inch, overall diameter 0.890 inch (max).

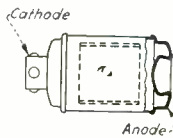
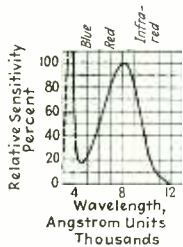

**Luminous Sensitivity**  
 0 cps (dc) = 20  $\mu\text{a/lumen}$   
 1000 cps = 20  
 5000 cps = 20  
**C(cathode-anode) = 0.5  $\mu\text{f}$**   
 Max Ambient Temp = 100° C  
 Max Anode Supply Voltage = 500 v  
 Max Anode Current = 30  $\mu\text{a}$   
 Sensitivity = 0.0020  $\mu\text{a}/\mu\text{watt}$   
 radiant flux at 8000 A. See curve.

### Type 923

R.C.A.

GAS phototube, caesium coated cathode, window area 0.4 inch, seated height to center line of cathode 1 31/32 inch, overall length 3 9/16 inches (max), overall diameter 1.165 inch (max), 4-pin base.

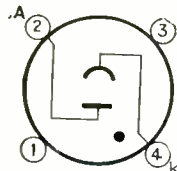
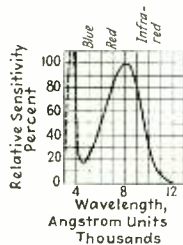

Gas Amplification Factor—Not over 9.  
**Luminous Sensitivity**  
 0 cps (dc) = 100  $\mu\text{a/lumen}$   
 1000 cps = 94  
 5000 cps = 87  
**C(cathode-anode) = 2.0  $\mu\text{f}$**   
 Max Ambient Temp = 100° C  
 Max Anode Supply Voltage = 90 v  
 Max Anode Current = 20  $\mu\text{a}$   
 Sensitivity (E anode supply) = 90 v and  $R_1 = 1 \text{ megohm}$   
 = 0.0090  $\mu\text{a}/\mu\text{watt}$  radiant flux. See curve.

# DAVEN

## TRANSMISSION MEASURING SETS

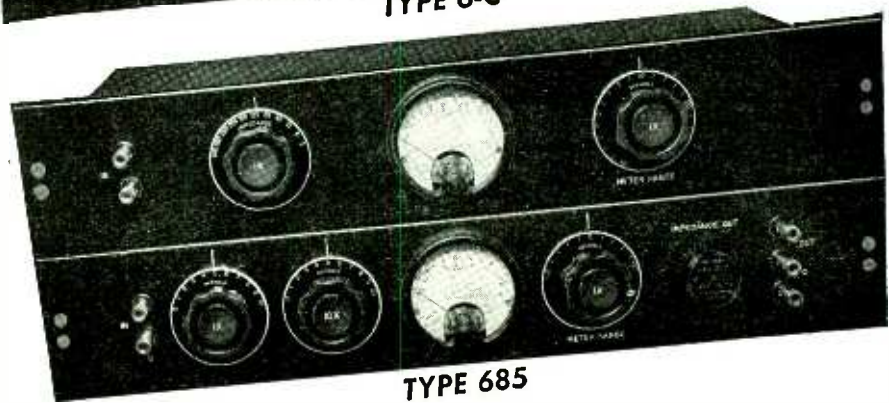
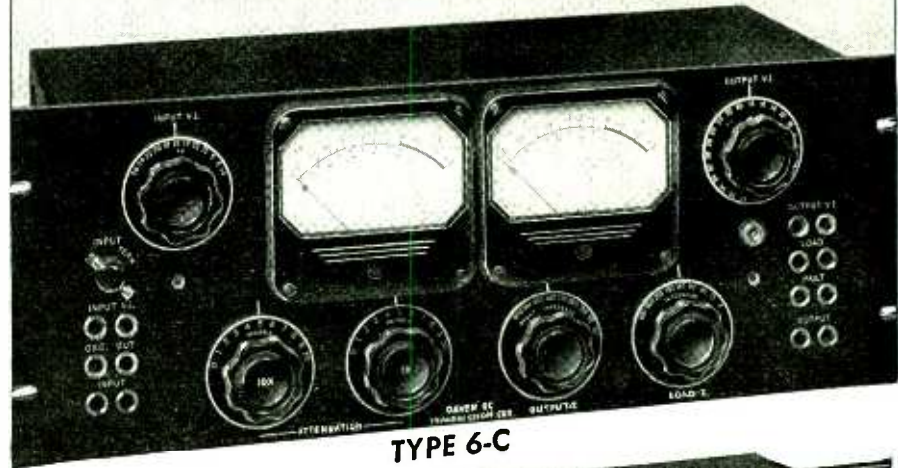

**TYPE 6-C** Designed in co-ordination with the General Engineering Department of the Columbia Broadcasting System, the 6-C Transmission Measuring Set consists of complete transmission and load units assembled on a single rack type panel. With a frequency range from 30 to 17,000 cycles, this set provides an accurate and rapid method for measuring the transmission characteristic of networks at audio frequencies.

The reference level is the new standard of 1 mw. across 600 ohms. New Weston Type 30 meters are employed. The attenuation range is from Zero to 110 db. in steps of 1 db. Power range is calibrated from -16 to +45 db. Dial selection of useful network input and load impedances. No correction is required when changing impedances. Overall accuracy is  $\pm 2\%$ . **\$325**

**TYPE 685** An unusually flexible, universal gain measuring instrument for rapid and accurate measurement of overall gain, frequency response and power output of audio amplifiers, this assembly has a useful frequency range from 30 to 17,000 cycles.

It is direct reading in decibels and does not require correction factors or calibration charts. All networks meters and associated apparatus are shielded and carefully balanced, matched for uniform accuracy over this wide frequency range.

Attenuation range is +10 db. to -120 db. in steps of 1 db. Power measuring range is -20 db. to +36 db. Eleven load impedance values, ranging from 5 to 600 ohms are available. Output impedances may be changed from "balanced" to "unbalanced" and to any loss impedance by means of plug-in type matching networks. Overall accuracy is  $\pm 2\%$ . **\$225**

The DAVEN catalog lists the most complete line of precision attenuators in the world: "Ladder", "T" type, "Balanced H" and Potentiometer networks—both variable and fixed types—employed extensively in control positions of high quality program distribution systems and as laboratory standards of attenuation.

Special heavy duty type switches, both for program switching and industrial applications are available.

Super DAVOHM resistors are precision type, wire-wound units from 1% to 0.1% accuracy.

More than 80 laboratory test equipment models are incorporated in this catalog.

**THE DAVEN COMPANY**  
 158 SUMMIT STREET • NEWARK, NEW JERSEY

An Advanced  
Communications  
Design

THE  
*Skyrider*

The new 1942 Skyrider 32 is a moderately priced communications receiver that will deliver high quality performance. Covers everything on the air from 500 kc. to 40 mc. Thirteen tubes, six bands. Two stages preselection. Calibrated bandspread inertia controlled. Micrometer scale tuning inertia controlled.

Tone and AC on-off. Beat frequency oscillator. AF gain—RF gain. Crystal phasing. Adjustable noise limiter. Send-receive switch—AVC-BFO switch 80/40/20/10 meter amateur bands calibrated. Wide angle "S" meter. Push-pull high fidelity, audio output. 6-step wide range variable selectivity.

Engineered by Hallcrafters, the Skyrider 32 will produce superior communications performance at a moderate price.

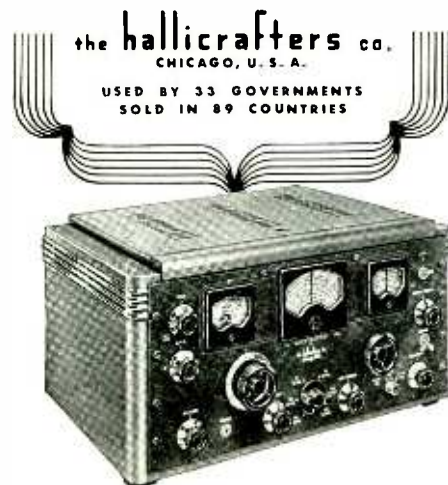

## CBS Goes to Latin America

(Continued from page 33)

which the antenna is designed and is usually more than 0.5 wavelength. The 6 Mc antennas are supported from 220-foot masts and the 21 Mc antennas from 80-foot poles. The arrangement of CBS and Mackay antennas is shown in Fig. 4.

A drawing of a typical array, (antenna number 7) is shown in Fig. 5. This is designed for operation on 9650 or 11830 kc. It has a calculated gain of 15 db at the lower and 16 db at the higher frequency. Field tests with small scale models give results which corroborate the antenna design calculations and thus, it is believed that anticipated performance will be realized in practice.

Reflectors are used to obtain an additional gain of almost 3 db in the forward or desired direction of radiation. This is equivalent to doubling the carrier power of the transmitter, with the additional advantage of reducing backward radiation which, on the higher frequencies, sometimes results in impairing the quality of reception due to echo effect. When radiated both forward and backward the signal arrives at the receiving antenna over two different great circle paths of different lengths. Echoes sometimes arise, even when unidirectional radiation takes place, because the signal is received twice, once initially and approximately 1/7 second later, after it has travelled around the world.

Directivity of three of the antennas (numbers 9, 10, and 11) may be reversed 180 degrees by remote control, and these antennas may be used for transmission to Europe or to Mexico and Central America. Directivity is altered by interchanging the transmission line and reflector line matching stub with the radiator and reflector, using two double-pole, double-throw switches, as shown in Fig. 6.

Typical horizontal polar patterns for two-program simultaneous transmission to various points of the world and representing typical combinations of antenna arrays as they will be used in practice are shown

## don't worry about it!

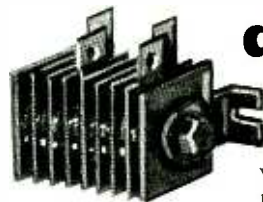

Whatever your problems or requirements are in changing Alternating Current to Direct Current, let a B-L Rectifier be of service to you. B-L Rectifiers are used for all applications—battery charging, electric welding, electric plating, magnetic chucks, signal systems, battery substitutes, airplane starters, quantitative analysis, electrolysis—these are a few of the many uses for B-L Rectifiers.

Our engineers have been designing and building rectifiers for many years. They are thoroughly qualified to serve you promptly and economically with rectifiers that really fit your individual needs.

Write or wire today for complete information.



THE BENWOOD LINZE CO.  
1805 LOCUST ST.  
ST. LOUIS, MO.  
MANUFACTURERS ENGINEERS

## ★ Brightest Star in the Audio Oscillator Field



Model 652

★ Here is a tried, proven and accepted Audio Oscillator whose brilliant performance sets it apart from other makes. Success is due to a basic new principle of operation. Audio Frequency voltage is developed at its Fundamental Frequency. This is not a "beat frequency" oscillator and contains no R.F. circuits. Operation is vastly simplified. Characteristic faults of old style methods are eliminated. Model 652 is accurate to within 3%, or one cycle. Many outstanding features. Price \$74.50

Write for descriptive literature

★ THE JACKSON ELECTRICAL INSTRUMENT COMPANY

123 Wayne Avenue Dayton, Ohio



in Figs. 7 and 8. The contours do not indicate coverage nor absolute field intensity values, but they do show the direction of maximum radiation.

#### Operating Conditions

The best transmitting and receiving apparatus is of limited usefulness unless a number of frequencies (at least one or more in each band) are available for this service. In general, the lower frequencies are good for night transmissions over paths of complete darkness, the higher frequencies for daytime transmission and the intermediate frequencies (15 and 11 Mc bands) for transitional periods of time, i.e., when the transmission path is partly in darkness and partly in daylight. Because several variable factors greatly influence the propagation characteristics of short waves, it is necessary to use the frequency best suited for an existing condition of transmission. Upon the proper choice of frequency depends to a large degree the success or failure of a shortwave broadcast or relay.

The frequencies selected for daily operation, i.e., the station operating schedule, are determined by an exhaustive study of:

1. National Bureau of Standards radio wave propagation data.
2. Field intensity measurement data.
3. Professional reception reports, such as those of the B.B.C. receiving station at Tatsfield, England.
4. Frequency measurements made by the Union Internationale de Radiodiffusion Control Center at Berne.
5. Reports from CBS representatives.
6. Correspondance from short-wave station listeners.

#### References

<sup>1</sup>R. J. Rockwell and H. Lepple. A Push-Button-Tuned 50-kw Broadcast Transmitter. *Electrical Engineering*, January 1941.

<sup>2</sup>Andrew Alford and Sidney Pickles. Radio Frequency High Voltage Phenomena. *Electrical Engineering*, March 1940.

<sup>3</sup>Andrew Alford. High Frequency Transmission Line Networks. *Electrical Communication*, January 1939.

<sup>4</sup>Andrew Alford. Coupled Networks in Radio Frequency Circuits. *Proc. I.R.E.*, February 1941.

<sup>5</sup>G. C. Southworth. Certain Factors Affecting the Gain of Directive Antennas. *Proc. I.R.E.*, September 1930.

## FLUCTUATING LINE VOLTAGE



## CONSTANT VOLTAGE

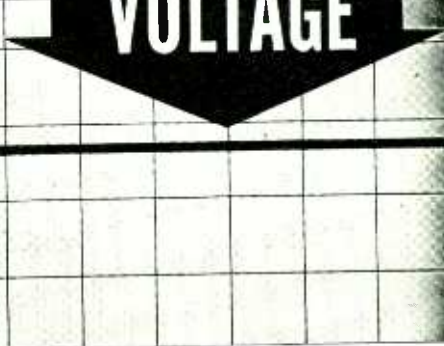

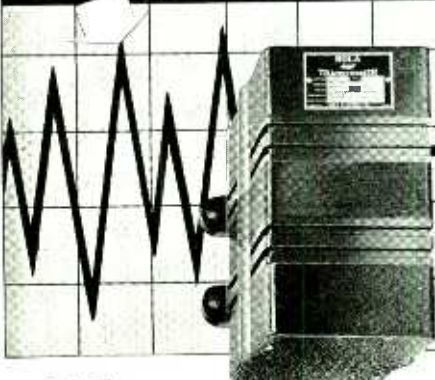

**Ask For  
BULLETIN  
DCV-74**



Whether it's 1 VA for an instrument or 10 KVA for a production line—here's constant, stable voltage for you at all times, even though the line voltage varies as much as thirty percent.

They are fully automatic and instantaneous in operation—have no moving parts—require no maintenance—and are self-protecting against short circuit.

You can build a SOLA CONSTANT VOLTAGE TRANSFORMER into your product, or incorporate it in your production line or laboratory and know that every test will be made under identical line conditions. Compact—economical. Standard designs are available, or units can be built to your special specifications.

**SOLA ELECTRIC COMPANY, 2525 Clybourn Ave., Chicago, Ill.**

# S O L A

## Constant Voltage TRANSFORMERS



## TYPE "C" Electro-Magnetic RELAY

**Small, Economical, Durable**

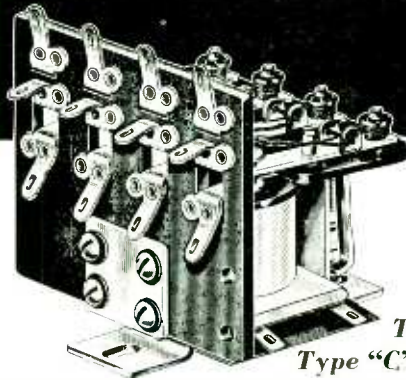

*This is  
Type "C" four  
pole, double throw  
electro-magnetic Relay*

If your requirements call for small 1, 2, 3 or 4 pole, single or double throw relays, we believe you will find the new G-M Type "C" relay a superior relay for your purpose. It possesses those essential elements of long mechanical and electrical life.

Type "C" relays are available with a variety of contact materials for different load requirements. The design provides self-cleaning wiping action in normally open or closed contact positions. Machine assembly of parts provides economical, low-cost production.

Our recently completed factory provides large production facilities, assuring prompt service.

**Write Today For  
Bulletin No. 607**

*A detailed description of the  
Type "C" Relay is necessary  
in order to appreciate fully  
its outstanding qualifications  
and possibilities. Send for  
Bulletin No. 607 now.*

# G-M LABORATORIES INC.

**4313 NORTH KNOX AVE. CHICAGO, U. S. A.**



# THE ELECTRON ART

**A five-band auto receiver, a method for measuring dynamic characteristics of vacuum tubes, the public use of inventions, and electronic switches for cathode ray oscilloscopes are reviewed this month**

## Five-Band Auto Receiver

THE PROBLEM OF INADEQUATE radio service in large portions of this country and a suggested solution are discussed by J. H. Little and F. X. Rettenmeyer in "A Five-Band Receiver for Automobile Service," which appears in the April 1941 issue of the *Proceedings of the I.R.E.* The greatest need for improved signals is in the southern regions where the static level is the highest and where it continues for a longer portion of the year than in other parts of the country. In the Rocky Mountain states, where the population is scattered and radio stations are scarce, there is also a great need for improvement in so far as adequate daylight coverage is concerned. A large part of the continental United States and particularly that portion which represents the recreational areas, is not adequately served by standard broadcast stations. Auto radios tend to add to the large concentrations of the radio listening population in recreational areas during certain seasons of the year. The automobile receiver, being mobile, adds another serious aspect to this situation in that the receiver may move through territories inadequately served by standard broadcast stations. At the present time there are about 30,000,000 registered automobiles in this country of which 8,000,000 or about 27 per cent are equipped with radio receivers. This indicates the importance of the automobile radio in the social life of our population, and it is obvious that large masses of the population cannot be served properly either during the day or night with standard broadcast band auto receivers. A suggested solution to this problem is to make use of the international short-wave broadcast bands. The authors discuss in considerable detail short-wave propagation phenomena to prove their point.

A 9-tube five-band auto radio receiver, designed for reception on the international short-wave bands as well as the standard broadcast bands is described. The tube line-up is as follows: one 6K7 tuned radio-frequency stage on all bands, one 6SA7 converter, two 6SK7 i-f stages, one 6SR7 as a second detector, first audio-frequency stage and noise-limiter control, one 6H6 noise-limiter automatic-volume-control tube, and two 6V6GT output tubes in push pull. A three-circuit permeability tuner is employed on all bands.

An unorthodox construction has been developed for the r-f system which mounts all of the essential components pertinent to a single stage within a single shield can. Each coil unit contains a broadcast-band tuning coil, a short-wave spread-band tuning coil and fixed trimmed shunt coils for each of the spread bands. The use of the separate coils for each short-wave band provides independent control of alignment and dial calibration on all bands by direct alignment methods and without compromise. The unit type of construction makes it possible to bring a minimum number of leads out of each coil unit. This results in a minimum of intercoupling in a layout which is very closely limited in space. It also provides a minimum amount of interference pickup from the power supply of the receiver or from the ignition system of the automobile. The broadcast coils and the short-wave spread-band tuning coils are both permeability tuned.

The oscillator is of the modified Colpitts type on the broadcast band and of a Hartley type on the short-wave bands. The oscillator of the broadcast band is designed to track the signal-frequency circuits by means of a variable-pitch winding of proper diameter. The oscillator coils of the short-wave circuits are arranged to tune with a relatively large fixed capacitor which has a proper negative temperature coefficient to obtain maximum oscillator stability.

The mechanical design considerations are discussed in some detail, especially the solenoid tuner and the range switch. The tuning mechanism is a five-position solenoid-actuated unit complete with manual drive, solenoid clutch, pointer, and drive, with provisions for setting up stations with one band without the use of tools.

It is suggested that properly located long-wave high power broadcast stations similar to those in Europe might offer one solution to the problem of coverage in this country. However, a project of this kind that would provide adequate choice of programs would appear to be faced with serious economic handicaps and in addition would require the assignment of frequencies now in use for aircraft navigation. It is believed, however, that a more economical approach and one which could be more nearly self-supporting might be set up in the present international short-wave band. One possibility might be the use of non-directional antennas by international short-wave stations operating on frequencies unsuitable for transmission to another continent.

## THE INSIDE OF ANOTHER ATOM SMASHER

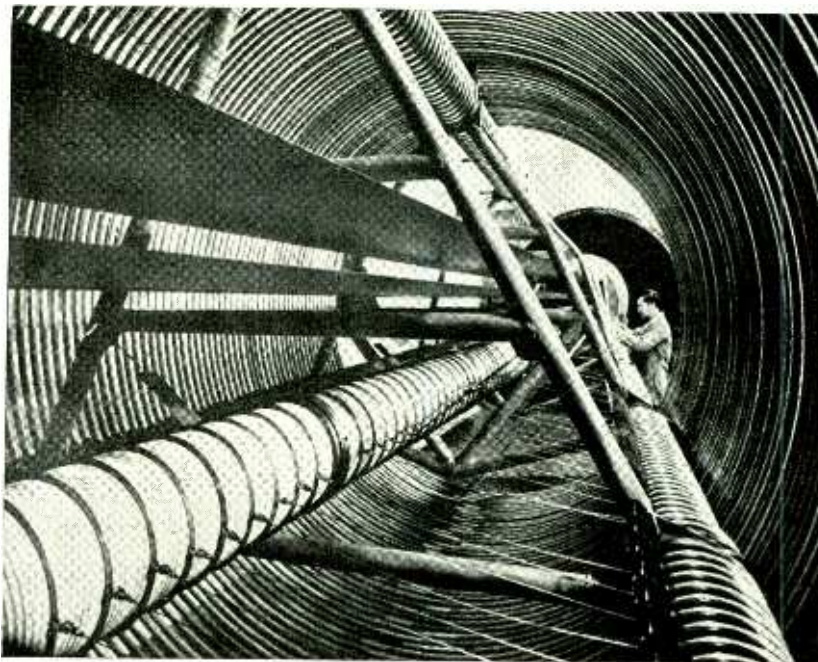

This twenty-ton electrostatic generator, rapidly nearing completion under the supervision of physicists at the University of Notre Dame, will generate eight million volts. The device will be used in an extension of a program of research in atomic disintegration



## Measurement of Dynamic Characteristics of Vacuum Tubes

A CIRCUIT FOR RAPIDLY measuring the dynamic characteristics of vacuum tubes is described in the May 1941 issue of the *Bell Laboratories Record* by J. B. Maggio. The older method involves the measurement of the static characteristics of the vacuum tubes and from them, determining the dynamic characteristics. This method possesses certain disadvantages. The new method overcomes these disadvantages by making direct measurements on the tube under a-c conditions. A dynamic transfer curve may thus be obtained rapidly and under conditions that hold when the tube is in normal use. A simplified circuit is shown in Fig. 1. In brief, the method consists in applying the desired d-c plate and grid biasing potentials, and then superimposing on the grid bias a pure sinusoidal driving voltage of carefully determined value, and measuring the corresponding plate current. The method is indicated in Fig. 2. Any set of plate and grid voltages determines a quiescent point as *Q*. For any applied alternating driving potential, the grid voltage is driven alternately above and below the grid voltage of the quiescent point, and the plate current will alternately increase and decrease. The plate current has an a-c and a d-c component, the latter is determined separately and the maximum positive and negative peaks of the a-c component are added to and subtracted from it to give the plotted points of the dynamic characteristics.

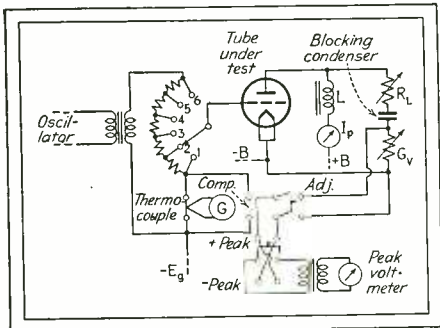

Fig. 1—Simplified circuit for measuring dynamic characteristics

The driving circuit consists of a tapped potentiometer made up of equal resistance steps, one of which is the heater of a thermocouple. An oscillator applies a pure sinusoidal voltage to the potentiometer, and its output is adjusted until the galvanometer connected to the thermocouple indicates a 1-volt peak. Under these conditions, the steps of the potentiometer apply to the grid multiples of 1 volt peak from the bias voltage.

The alternating and direct components of the plate current are separated by a parallel circuit. One branch consists of the large inductance *L*, and the other of an adjustable resistance *R<sub>L</sub>*, a

HAVE YOU  
TRIED THE NEW  
PRESTO  
GLASS "Q" DISC



A heavy plate glass base coated with the famous Presto "Q" compound . . . smoother . . . flatter . . . more uniform in thickness than any metal base recording blank.

Made heavier (3/32") for added durability. Handle it like any transcription.

Has 2 standard holes for the turntable shaft and the drive pin that prevents slippage of the disc or cutting mechanism.

Made in the new Presto \$250,000 disc plant. Now ready for you in the 12" and 16" sizes. Immediate shipment, any quantity.

Phone your radio distributor for new net prices to radio stations and studios.

**PRESTO**  
RECORDING CORP.  
242 WEST 55th ST. N.Y.

In Other Cities, Phone . . . ATLANTA, Jack, 4372 • BOSTON, Bul, 4510  
CHICAGO, Mar, 4240 • CLEVELAND, Me, 1565 • DALLAS, 37093 • DENVER,  
Ch, 4277 • DETROIT, Univ, 1-0180 • HOLLYWOOD, Hil, 9133 • KANSAS  
CITY, Vic, 4631 • MINNEAPOLIS, Atlantic, 4216 • MONTREAL, Wel, 4218  
PHILADELPHIA, Pennly, 0542 • ROCHESTER, Cal, 5348 • SAN FRANCISCO,  
CO, Yu, 0231 • SEATTLE, Sen, 2360 • WASHINGTON, D. C., Shep, 4003  
World's Largest Manufacturers of Instantaneous Sound Recording Equipment and Discs

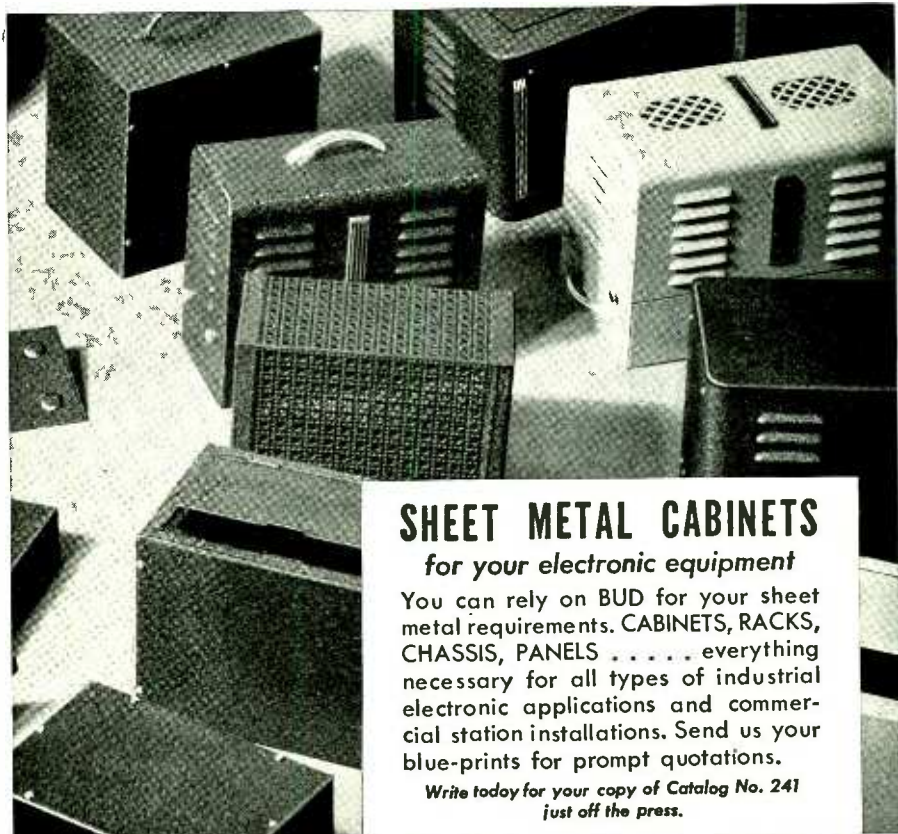

## SHEET METAL CABINETS

for your electronic equipment

You can rely on BUD for your sheet metal requirements. CABINETS, RACKS, CHASSIS, PANELS . . . . everything necessary for all types of industrial electronic applications and commercial station installations. Send us your blue-prints for prompt quotations.

Write today for your copy of Catalog No. 241  
just off the press.



**BUD RADIO, INC.**

CLEVELAND, OHIO





Another  
**DuMONT**  
**TELEVISION**  
 Scoop!

★ With the DuMont Electronic View-Finder—virtually a miniature television attached directly to the television camera—video broadcasting takes another jump ahead.

The television camera operator now sees precisely what he is passing on to his audience. He sees the television image itself. He can check on lighting, shadows, contrast. Meanwhile, this finder does away with costly matched lenses, troublesome parallax, the changing of finder lenses as "taking" lenses are changed. The image is far brighter than that of the usual optical finder. The cost of the camera is considerably reduced.

This latest development is typical of the advanced engineering of DuMont television equipment, now available to video broadcasters. Vitally interested? Write for details.



smaller resistance  $G_v$ , and a large blocking condenser which prevents the passage of direct current through this branch. At the test frequency, the impedance of  $L$  is so large compared to that of the other branch, that only direct current passes through it. Thus the d-c component flows through  $L$  and is measured on a milliammeter, while the a-c component flows through the  $R_v$  branch, and is measured by adjusting  $G_v$  until the peak voltage across it is just one volt, which is determined by comparison with the voltage across the thermocouple in the grid circuit. The set thus measures the behavior of the tube in a circuit where the impedance presented to the plate is low to direct current, and a pure resistance at frequencies in the working band. Such conditions are normally fulfilled in a transformer-coupled output stage, such as is used in most broad-band carrier amplifiers. The behavior of the tubes in resistance-coupled amplifiers may be readily determined by a suitable interpolation.

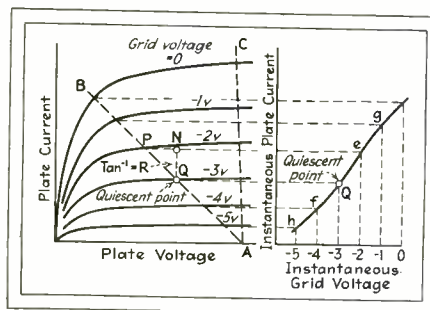

Fig. 2—Typical static characteristics of a tube and the dynamic transfer characteristics derived from them

Since the voltage across  $G_v$  is the  $IR$  drop through it, the current through it is equal to the reciprocal of the resistance when the voltage drop is unity. Thus, by using a conductance standard for  $G_v$ , the current in milliamperes is equal to the conductance in millimhos. The scale of the conductance standard is marked in milliamperes in order to make it direct reading.

The current measured on the milliammeter is the d-c component of the plate current for the plate potential and grid bias applied. With the grid potentiometer set at the 1-volt step and assuming the conditions of Fig. 2 the positive peak of a-c plate current added to the d-c component would give the point  $e$  of the right-hand diagram of Fig. 2, and the negative peak subtracted from the d-c component would give the point  $f$ . A separate adjustment of  $G_v$  is required, of course, for positive and negative peaks. Similar readings with the potentiometer on step 2 would determine points  $g$  and  $h$ , and so on for other points. Asymmetric distortion of the dynamic transfer characteristic results in a change of d-c plate current when the signal is applied. When this occurs, the d-c bias is adjusted to compensate for change. Characteristics corresponding to Class B and Class C operation may be taken in this way.

## Journal of Physics (U.S.S.R.)

VOLUME III (1940) of the *Journal of Physics* published by the Academy of Sciences of the U.S.S.R. was recently received by the editors. Most of the articles are in the realm of pure physics and some typical titles are: The Scattering of Photo-Neutrons by Nuclei, The Angular Distribution of the Shower Particles, Spontaneous Fission of Uranium, The Isomerism of Atomic Nuclei, Some New Physical Methods Applied to the Problem of the Rational Location of Oil Wells, Synchronization of a Thyatron Generator, The Radiometric Effect in Liquid Helium, Theory of Non-Stationary States of the Electric Discharge Plasma, Twinning of Chile Saltpeter under Plastic Strain, Radiation of an Electron Moving in a Crystal with a Constant Velocity Exceeding That of Light, and The Displacement Caused by Tension in the Critical Values of Superconductivity for Tantalum. Most of the articles are in English with a few in German. The volume contains 524 pages in six issues.

Issue 4-5 of this volume is dedicated to Professor A. F. Joffe, an outstanding Soviet scientist whose work has won recognition throughout the world. A six-page biography outlines his achievements in the fields of mechanical, electrical and magnetic properties of solid bodies, x-rays, electronics, and the physics of atomic nuclei. Prof. Joffe is also the founder and present head of the Leningrad Physico-Technical Institute, from which sprung several other similar institutes in the Soviet. Prof. Joffe, besides being a Member of the Academy of Sciences of the U.S.S.R., is a Member of the Prussian and Göttingen Academy, Member of the American Academy of Sciences and Arts, a Permanent Member of the International Solvay Council, and he holds an honorary degree from the University of California.

• • •

## Television in Wartime Germany

REFERENCE TO A SERIES of articles appearing in *Fernseh G.M.B.H.* of January 1941 indicates that television in Germany has continued under wartime conditions. This periodical contains seven articles discussing the various phases of television broadcasting and reception as well as large screen projection in a public theatre. An indication of the activities can be gained by a list of the articles appearing here. They are: Television Broadcasting with Ultrahigh Frequencies; Phase Control of a Series of Impulses; A New Frequency-Curve Indicator (for wide band amplifiers); Recent Advances in Television Receivers; Properties of Simple Magnetic Lenses and Measurement of Magnetic Fields with the Fluxmeter; Large-Screen Television Projection; and Television Film Scanners.



# *.. New Subscription Order Card ..*

---

---

Enter my new subscription to **ELECTRONICS** to start with the current issue. Bill me at the "special" rate of 3 years for \$10 — or the term checked below.

If you prefer 1 year - 12 issues - \$5 - check here

Name.....

Home Address.....

City and State.....

Firm..... Position.....

(Subscriptions quoted for U. S. and Possessions, Central and South America)

Canadian Rates: 1 year - \$5.50 — 3 years - \$11.00 — Payable in Canadian Funds at Par

FIRST CLASS  
PERMIT No. 64  
(Sec. 510 P. L. & R.)  
NEW YORK, N. Y.

**BUSINESS REPLY ENVELOPE**

No Postage Stamp Necessary If Mailed In The United States

4 Cents Envelope Postage Will Be Paid By—

**ELECTRONICS**

McGRAW-HILL PUBLISHING CO., Inc.

**330 WEST 42nd STREET,  
NEW YORK, N. Y.**





## Electronic Switching for Cathode-Ray Oscilloscopes

THE METHOD of observing several tube phenomena on a single cathode-ray tube received considerable attention in the April 1941 issue of *The Review of Scientific Instruments*. Three articles are published here and are as follows: "Combination Vacuum Tube Switch for Double-Trace Cathode-Ray Oscillograph, Audio-Amplifier and Mixer", by Harold K. Hughes and Richard F. Koch; "An Electronic Switch and Square Wave Oscillator", by J. R. Cosby and C. W. Lampson; and "An Electronic Switch for the Simultaneous Observation of Two Waves with the Cathode-Ray Oscillograph" by Herbert J. Reich.

In the article by Messrs. Hughes and Koch two circuits are described which are in effect medium-speed, single-pole, double-throw switches to alternately connect two independent voltages to the input of a single-beam cathode-ray oscillograph. In each of these switches a square wave is applied to the cathodes of two high- $\mu$  pentodes, biasing them beyond cut-off on alternate half cycles.

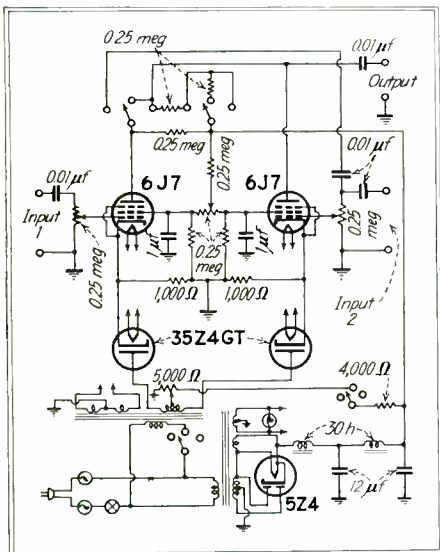
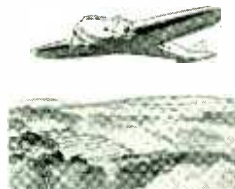

Fig. 1—Electronic switch using diodes operating at voltage saturation to obtain the square wave

The independent input voltages are applied to the control grids and the output is taken from the common plate connection. The two circuits differ only in the means of generating the square wave. In one, a high voltage transformer connects to the plates of two diodes which are run at reduced heater current to secure voltage saturation. In the second circuit a transformer swings the grids of two high transconductance, sharp cut-off television amplifier pentodes, overloading the grids on positive peaks and cutting off the plate current on negative peaks. The circuit diagram of the first circuit is shown in Fig. 1. The total cost of parts for this circuit is less than \$16.

The switch described by Messrs. Cosby and Lampson uses a 6N7 connected as a multivibrator. This circuit is



MOLDED

## S.S. White RESISTORS

The "All-Weather" Resistors

1000 OHMS TO 1,000,000 MEGOHMS

### PREFERRED for Aircraft and Marine Radio—

The materials and construction of these resistors is such that their operation is unaffected by extremes of temperature, humidity and rapid climatic changes. This makes them ideal for radio equipment used aboard military and commercial aircraft and ships. Representative users include Air-Track Mfg. Corp., Arma Corp., Pan American Airways, RCA, U. S. Army and Navy, Westinghouse and many others.

### SEND FOR RESISTOR BULLETIN 37

It contains illustrations of the various types and gives details as to construction, capacities, dimensions, etc. A copy, with Price List, mailed on request. Write for it today.

## S. S. WHITE

The S. S. White Dental Mfg. Co.

INDUSTRIAL DIVISION

Department R, 10 East 40th St., New York, N. Y.

## PRECISION INDUSTRIAL AND LABORATORY TESTERS

"Precision" manufactured to "Precision" standards of accuracy, workmanship and materials to give lasting satisfaction under the most exacting conditions of service.

### NEW SERIES 834 31 RANGE AC-DC COMPACT CIRCUIT TESTER

6000 Volts • 600MA • 5 Megohms • 70 DB

6 AC—6 DC—6 output voltage ranges to 6000 volts • 4 current ranges to 600 MA • 3 self-contained resistance ranges to 5 megs • 6 DB ranges to +70 DB • All 1% multipliers and wire wound bobbins • Size 7" x 4 1/2" x 3" overall.

An incomparable value at only \$17.95 net



### SERIES 854-J★

20,000 ohms per volt Super-Sensitive Industrial Circuit Tester—provides complete AC and DC circuit analysis to 6000 volts AC and DC • 70 DB • 60 AMPS. A.C. • 12 AMPS D.C. • 60 Megs • Complete with battery and test leads ..... \$65.95 net



WRITE FOR "PRECISION" CATALOG 42-E describing more than 40 radio and electrical test equipment models . . . Tube Testers, Combination Tube and Set Testers, AC-DC Multi-range Testers, Vacuum Tube Multi-range Testers, Signal Generators, Industrial Circuit Testers, etc.

## PRECISION TEST EQUIPMENT

INDUSTRIAL • LABORATORY • RADIO • TELEVISION

PRECISION APPARATUS COMPANY • 647 KENT AVENUE • BROOKLYN, N. Y.  
Export Division: 458 Broadway, New York City, U.S.A. Cable Address: Morhanex

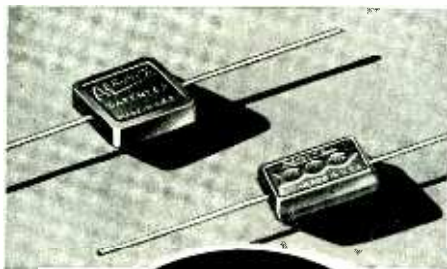

● For applications requiring precise capacity values, such as pushbutton tuners, fixed-frequency oscillators in low-power transmitter stages, r.f. filters, wave traps, tracking oscillator tuning section of super-heterodyne receivers, and for tuning i.f. transformers, Aerovox offers:

**SILVER MICAS . . .**

Molded in low-loss red bakelite for immediate silver-mica identification. "Postage stamp" design and dimensions. Silver coating applied to mica and fired at elevated temperatures. Positive bond and permanent stability with respect to time, temperature, humidity. Sections thoroughly wax-impregnated and molded in bakelite casing. Units heat-treated and wax-impregnated externally for protection against moisture penetration. Average temperature co-efficient of only .002% per degree C. Excellent retrace characteristics. Practically no capacity drift with time. Exceptionally high Q—as high as 3000 to 5000 in higher capacities. Made to tolerances as close as 1%. .000001 to .0025 mfd. 1000 v. D.C.T., and .003, .004 and .005 mfd. 600 v. D.C.T.

**MICA PADDERS . . .**

Screwdriver-adjusted mica capacitors which can be set to very close capacity values—even to 1%. Can also be readjusted to compensate for slightest variation in coils and circuit conditions, as required. Stabilized by heat treatment and by use of special impregnating materials. Low capacity-temperature variations. Excellent retrace characteristics. In four mounting types. .000075 to .01 mfd., 600 v. D.C.T.

**Submit Your Problem . . .**

Whether it be precision micas or other types, send us your requirements.

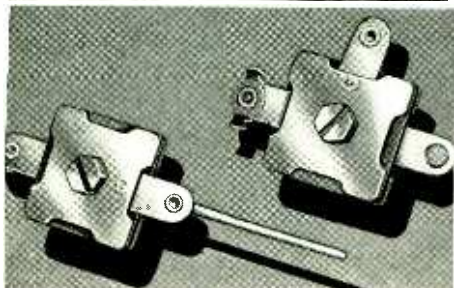

shown in Fig. 2. The output of the multivibrator is applied to two 6F5 tubes which produce a more perfect square wave of greater amplitude. This square wave acts as the switching potential and is applied in the No. 1 grids of the 6L7. The phenomenon to

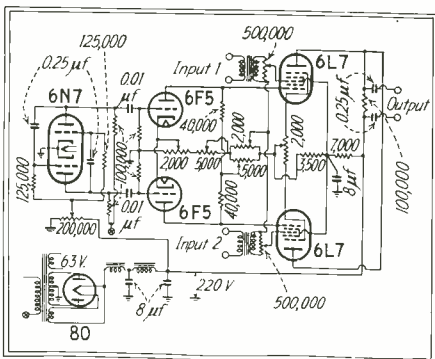

Fig. 2—This circuit uses a multivibrator and two 6F5 tubes to obtain the square wave

be observed is applied to the No. 3 grid of each tube. The output of the 6L7 is then applied to the vertical plates of the oscillograph. It is estimated that the cost of building this device is less than \$25.

The method of obtaining electronic switching used by Herbert J. Reich consists of a vacuum tube trigger circuit connected to a two-path amplifier in such a manner that one or the other amplifier tube is rendered inoperative by the high biasing voltage obtained

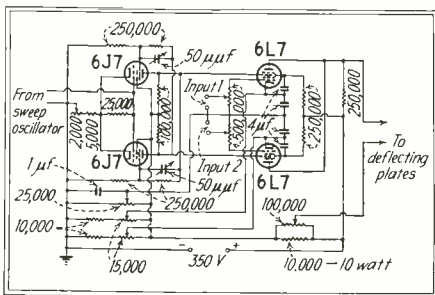

Fig. 3—Here a trigger circuit is connected to a two-path amplifier to obtain the square wave

from the plate resistors of the trigger tubes and applied to one grid of the amplifier tube. If the triggering impulse is obtained from the sweep oscillator, the circuit is triggered during each return sweep of the fluorescent spot and hence the two amplifier tubes amplify during alternate sweeps and the signal voltages are traced on the screen during alternate sweeps. This circuit is shown in Fig. 3.

• • •

**What is FM?**

SUCH RAPID PROGRESS is being made in the development of frequency modulation that almost any article on the subject makes timely and interesting reading. Most articles however, are written on a particular phase of the subject

and the reader is often conscious of the lack of a background knowledge on the subject. "What is FM", by William H. Capon, *Electrical Communications*, (Vol. 19, No. 4) answers this need. General in scope, the article is technical enough to give sufficient information without becoming academic.

There are several transmitting schemes used in frequency modulation. One of the basic schemes uses a condenser microphone (Fig. 1) whose impedance will vary in accordance with the sounds that impinge upon it. This device is used to modulate the output of an oscillator which is fed into the antenna. Another system uses a variable reactance modulator. Here the output of the speech amplifier is used as the control grid bias of a vacuum tube so connected that the variations in

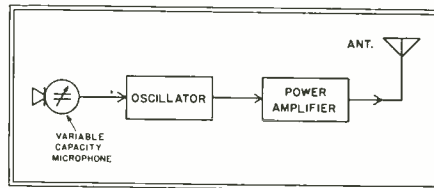

Fig. 1—A simple f-m circuit

grid bias change the effective inductance of the oscillator tuned circuit and cause its resonance frequency to change according to the modulation amplitude.

The Armstrong system is quite different from the systems just discussed. The output of an oscillator is multiplied in frequency by frequency multipliers to give the unmodulated carrier. (See Fig. 2.) A portion of the oscillator output is combined with a modulating signal in a balanced modulator which is so designed that it produces no output unless there is a modulating signal. This combination

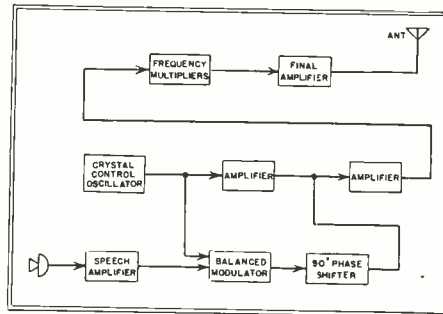

Fig. 2—Block diagram of the Armstrong f-m system

is fed into a circuit which shifts the phase 90 degrees. This signal and the oscillator output are combined as shown in the diagram. The combination of these two out-of-phase waves produces a frequency modulated wave whose frequency variation is proportional to the amplitude of the modulating frequency. An interesting feature of this circuit is that receiver-type tubes are used throughout except in the final power stage. A crystal control circuit is added to keep the mean frequency constant. This operates so that the



frequency of the oscillator, when not being modulated, is compared to a crystal-controlled reference oscillator whose frequency is different from the mean frequency by a fixed amount. The resulting voltage is rectified and used as the normal bias for the control element of the modulator tube. The audio modulation is also fed into this element. Therefore, any change in the mean carrier frequency will cause a change in the normal bias of the modulator tube and brings the oscillator mean frequency back to its correct value.

The Western Electric synchronized f-m system stabilizes the mean frequency in a unique manner. Here the speech amplifier output modulates the output of a tuned oscillator whose frequency is about 5000 kc if the final carrier is 40 Mc. A small amount of the modulated 5000 kc is reduced by frequency dividers to a value of 5000 cps. This low frequency is compared with the output of a precise crystal standard by means of a modulator which produces a rotating magnetic field whose speed and direction correspond to the deviation of the frequency

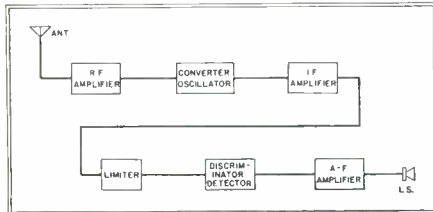

Fig. 3—Block diagram of an f-m receiver

in sense and amount. This field is applied to a small motor which drives the rotating tuning condenser of the 5000 kc modulated oscillator and comes to rest when synchronism is attained. The variations due to the frequency modulation are too rapid to cause any great change in the field and so do not affect the motor. The slightest change in the mean frequency however, causes the armature to rotate and to correct the frequency.

F-m receivers are basically the same as amplitude modulation superheterodyne receivers with the addition of a limiter and a discriminator-detector. The limiter stage is an amplifier so biased that it overloads when the amplitude of the incoming wave exceeds a certain amount. The purpose of this stage is to cut out any amplitude modulation which may have been introduced into the frequency modulated wave. This stage literally chops off the static from the wave. The discriminator-detector is a unit which converts the frequency modulation to amplitude modulation, and then detects or separates the intelligence from the carrier wave just as in an a-m receiver.

F-m transmitters must use ultrahigh frequencies because of the wide band widths necessary. Unlike a-m transmitters which have a non-modulated carrier of about one-fourth the peak power to permit handling of the 100 per cent modulation peaks, f-m units always operate at their peak power.



Clare relays are not just "telephone type" relays. The product of research by Clare Engineers results in relays of the general telephone type, yet so equipped to stand the rigors of industrial life. Our engineers are available for consultation and will be glad to recommend the proper relay for your application.

Cooperating for National Defense

Write for relay data book and catalog.

**C. P. CLARE & CO.**  
LAWRENCE & LAMON AVES. - CHICAGO  
15 EAST 26TH STREET, NEW YORK CITY

**"TENSITE"**  
*the 1.4 volt*  
**FILAMENT**

**WILBUR B. DRIVER CO.**  
NEWARK, NEW JERSEY

**CANNON ELECTRICAL CONNECTORS**  
*Save Time and Money . . . Increase Efficiency*

IN the transmission of electrical energy—electronic or otherwise—wherever cables are required, problems of efficient connection and quick disconnection are solved by CANNON Cable Connectors. Manufactured up to a standard and not down to a price. CANNON Multiple-Contact Electrical Connectors are the choice of the leading makers of fine equipment used in the fields of Sound, Aeronautics, Geophysical Research, Instrument Control on Ships and on Laboratory Panels.

*Illustrated Bulletins contain valuable information on Plug Problems. Bulletin "P & O" devoted exclusively to Sound. Please specify your requirements when requesting bulletins.*

**CANNON ELECTRIC DEVELOPMENT CO.**  
3209 HUMBOLDT ST., LOS ANGELES, CALIFORNIA  
Eastern Sales Office: 220 Fifth Ave., New York, N. Y.  
Chicago: Kelburn Engineering Co., 600 W. Jackson Blvd.

**CANNON PLUGS**

## CHAMPIONS OR TRANSFORMERS...



**Pedigree Counts**



There are lots of folks to whom any dog looks pretty much the same as another. But the champion that takes the grand prize at the Bench Show is the one with the pedigree . . .

And there are people to whom one transformer looks pretty much like another. The same kind of case, the same general specifications, the same ratings. But what a difference there can be!

Smart buyers of transformers do not rely upon appearances. They buy them on the basis of Reputation and Prestige (which is just another way of saying "Pedigree").

Kenyon transformers have that reputation for quality which is truly outstanding. They're found in Radio receivers, transmitters and electronic equipment bearing the name of America's foremost manufacturers.

You're always assured of "Blue Ribbon" performance when you KENYONIZE your equipment.

*New 1941 Catalog Ready. Send for your Free copy.*

**KENYON TRANSFORMER CO., Inc.**  
 840 BARRY STREET • NEW YORK, N. Y.  
 Cable Address: "KENTRAN"—New York

Tests have shown that where two f-m transmitters are operating at the same frequency within a short distance of each other (15 or 20 miles), the zone where neither station can be satisfactorily heard covers a very small area (2 or 3 miles across). Other tests show that when transmitters are separated by 200 kc in mean frequency the distant station can be received even under the antenna of the other station without interference if its signal strength is sufficient to operate the limiter of the f-m receiver.

• • •

### Electro-Acoustic Airplane Spotting

AN ELECTRO-ACOUSTIC METHOD of spotting airplanes and following their progress is described in the April 1940 issue of *Electronics and Television & Short-Wave World*. The instrument consists essentially of a parabolic reflector at whose focal point is placed a microphone. Surrounding the outer periphery of the reflector is an acoustic sheet adjustable in length so that it acts as a Helmholtz resonator. The resonator increases the sensitivity of the instrument and also reduces wind noises and pickup due to mechanical vibration. The signal from the microphone is fed into a high-gain amplifier which contains a special filter network so that it acts as an acoustic band-pass filter. Various bands of audio frequencies can be accepted and all others attenuated. The output of the amplifier is fed to headphones or to the deflector plates of a cathode ray tube.

The instrument is capable of picking up sounds from distances greater than eight miles and the angle of acceptance is less than 5 degrees. With a little practice an operator can easily follow the course of an airplane and determine the probability of enemy bombing in his own area. With this instrument the value of nuisance raiders to the enemy is greatly decreased because production in a factory can be maintained at the highest level compatible with safety.

• • •

### Public Use of An Invention

THE ALLIS-CHALMERS *Electrical Review* continues its fine series of patent articles with "Public Use in Private, or Vice Versa," by D. Journeaux in the June 1941 issue. To be valid, a patent application must be filed within one year from the first public use of an invention. On the other hand, experimental use of an invention is encouraged.

Frequently the question arises whether using an invention is public or whether it is experimental. With due caution it may be considered that an invention is in public use when it is used openly by the inventor for its intended purpose, and when it is used by any one beyond the control of the inventor. To apply this rule to any

particular instance it is necessary to bear in mind the explanatory statements made by the courts and the conclusions reached in cases involving similar conditions.

Taken literally, the public use statutes were always quite inflexible. It was not very long before inventors, or more probably, their counsel, had the brilliant idea that if a public use of an invention for more than two years (now one) before filing is a bar to the grant of a patent, there is no reason why some other kind of use could not take place at that time without having such an effect.

If an inventor decides beforehand that the first use of his invention will be experimental, makes his intentions clear to all persons involved in such use and conducts the use as an experiment, that use may extend over a number of years without invalidating a patent subsequently applied for. A famous example of experimental use was the dispute over an invention which consisted of a pavement of wooden blocks with wide joints filled with a mixture of tar and gravel and laid on a waterproof foundation. During a plea for infringement it was shown that the pavement had been used by the public for six years. However, the strip of pavement had been installed by the patentee at his own expense on a toll road owned by a corporation of which he was treasurer. The patentee had made it clear from the beginning that it was experimental, and had inspected its condition himself almost daily. In view of these circumstances the Supreme Court in 1878 held that there had been no public use of the invention and that the patent was valid. Thus was born the paradox of an invention being used by the public for years but without being in public use.

Going from one extreme to the other the same court in 1881 declared another patent invalid in a decision which has set the standard of non-permissible use. This decision gave birth to another paradox; that of an invention being in public use merely because it was used privately by one person other than the inventor. The invention in litigation was a double leaf corset spring which was devised to replace the fragile single leaf springs then in use, and to give to the feminine body the softly resilient support now more generally provided for automobile bodies. The inventor made some springs and gave them to his future wife without cautioning her to keep his idea secret. Apparently he did not have in mind that such use should be made under his direction as a scientific experiment. In 1866, when the inventor applied for his patent, the springs had somehow gained general acceptance by the trade. The patentee was too late to gather his reward, for in the words of the Supreme Court, "the inventor had slept on his rights for eleven years." His patent which had been reissued five times was held invalid. This article makes very interesting reading and should be useful to those engineers who believe they have patentable ideas.



# Backtalk

## Slant Bar

If values for 6J5 with  $R_k = 20,000$  ohms are substituted in your formula for output impedance of cathode-coupled amplifiers on page 51 of June ELECTRONICS,  $Z_o'$  comes out well over 100,000 ohms.

Very hasty check indicates that your equation should read

$$Z_o' = \frac{R_k r_p}{r_p + R_k(\mu + 1)}$$

Or am I crazy?

BEN DRISKO  
Hingham, Mass.

► There should be a slant bar between two portions of the numerator. This makes the formula read

$$Z_o' = \frac{R_k r_p / (\mu + 1)}{R_k + \frac{r_p}{\mu + 1}}$$

which is equal to your equation. Evidently, you are not crazy.—THE EDITOR.

• • •

## Voltage Multiplier

"Voltage Multiplier Circuits" by D. L. Waidelich which was published in the May 1941 issue of ELECTRONICS contained an error in Fig. 6. The correct diagram for Fig. 6 appears below.

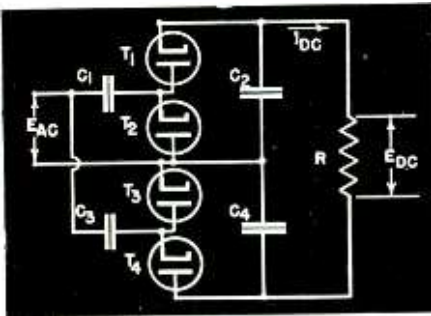

• • •

## Db vs VU

In a paper by D. R. King, entitled "A Ruler for Record Patterns", appearing in the May 1941 issue of ELECTRONICS, mention is made of the conversion of "ratios into decibels or volume units." Attention is called to the two errors in this statement.

The term "volume units" has never been applied to the abbreviation "vu" in any official literature (such as the paper appearing in the February 1939 issue of ELECTRONICS) relative to the new standard reference level.

Furthermore, the terms vu and db

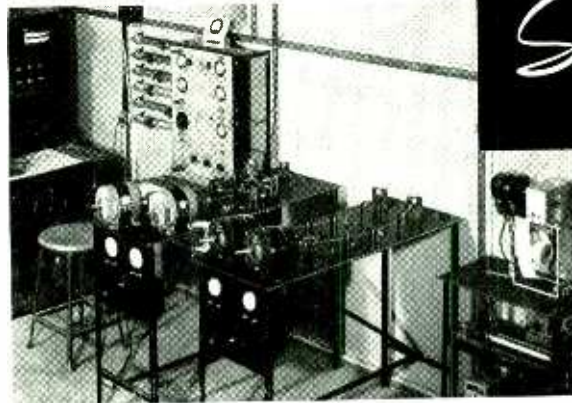

Partial View of one of our Test Laboratories

*It will do the job we rate it to do, it will have the right spring action!* Supplementing the cumulative knowledge of our spring engineers we have complete modern laboratories to determine *THE* correct answer to your spring problem. Hunter suggestions are based on tested facts, throughout. And, Hunter production facilities and methods deliver to you springs you can trust to perform faithfully to requirements.



HUNTER SPRINGS ARE ENGINEERED SPRINGS

HUNTER PRESSED STEEL CO. LANSDALE PENNSYLVANIA



a by-product that is  
now a PRODUCT

Expressly prepared for THE DAVEN COMPANY as a lubricant, this super-fine oil has been furnished, during the past few years, to purchasers of delicate and precise DAVEN laboratory equipment.

Liked so well, and reordered so frequently . . . it has necessitated the formation of a subsidiary organization, the DAVENOIL COMPANY.

DAVENOIL is recommended for all electrical laboratory test equipment, microscopes, cameras, watches, etc. . . . Leaves NO residue of dirt or sticky gum. Available in small bottles with applicator or in 8 ounce, 16 ounce and gallon containers.

DAVENOIL COMPANY  
158 SUMMIT STREET • NEWARK, N. J.

Springs  
by Hunter

When we say  
"IT WILL"  
—IT WILL

**New!**  
**Turner Cardioid**  
with Ribbon Velocity and  
Dynamic Pressure Elements

Licks  
Feedback



Out-Performs  
Many Mikes  
Selling at  
Twice the Price

Two elements are combined thru a specially designed transformer network, to obtain extremely high sensitivity to sounds in front of the microphone, and to completely deaden the rear. The ideal microphone for studio performance, P.A. men and recorders.

Standard Model 101A, List. . . . \$55.00  
De Luxe Model 101B, same as 101A, with 3-position switch, List. . . . \$65.00  
Broadcast Model 101C, same as 101B, with frequency extended to 10,000 cycles, List. . . . \$70.00

Write for Full Free Details

**THE TURNER CO.**  
Dept. E., Cedar Rapids, Iowa

**ALWAYS  
WORKING  
...but never  
weary**



In helping to meet today's commercial and defense demands, many a Leeds & Northrup "Micromax" Recorder is denied all holidays—works 24 hours to a shift, 7 days a week. For such constant service, Leeds & Northrup demands electrical contacts of high accuracy. And gets them—in Wilco materials. And just as Wilco meets these exacting requirements for electrical contacts—so do Wilco's Thermometals (thermostatic bimetals) provide dependability for temperature control—or reaction from temperature changes.

Whether your orders are large or small, they are personally supervised by an executive of The H. A. Wilson Co. And that means shipments that are right—every time! For full information, write: The H. A. Wilson Co., 105 Chestnut St., Newark, N. J. Branches: Chicago and Detroit.

*Now more than ever  
Personal  
Attention Counts*



**THE  
H. A. WILSON CO.**

**TAYLOR**  
**LAMINATED PLASTICS**  
Vulcanized Fibre • Phenol Fibre  
SHEETS, RODS, TUBES, FABRICATED PARTS  
**TAYLOR FIBRE COMPANY**  
Norristown, Pennsylvania



As business paper publishers for over fifty years, McGraw-Hill is uniquely equipped to offer complete, authoritative direct mail coverage of industry's major markets. Extreme accuracy is maintained (guaranteed to 98%) and through careful analysis of markets, complete classification of companies and personnel, etc., the widest possible selections are available. Send for handy reference folder, "Hundreds of Thousands of Reasons Why" which describes how McGraw-Hill Lists are built and maintained.

**What Fields Do You Want to Reach?**

Aviation  
Bus & Electric Railways  
Civil Engineering and Construction  
Coal Mining  
Electrical Construction

Electrical Industry  
Food Industries  
Metal Mining  
Metal Working Industries  
Process Industries  
Textile Industries  
Administrative Executives  
Electrical Dealers & Wholesalers  
Mill Supply Houses  
Power Services  
Product Engineering & Design  
Production and Maintenance  
Radio Dealers & Wholesalers  
Radio Engineering and Design

For further details, selections from above basic classifications, counts, prices, etc., or estimates on special lists . . . ask any representative or write to

Complete Lists Covering Industry's Major Markets



Complete Lists Covering Industry's Major Markets

are not interchangeable, since the former relates to an absolute volume level whereas the latter may be applied to any ratio. Since, in the aforementioned article, reference is being made to ratios the term "db" is the proper one, and by no stretch of the imagination can a relation be obtained between "vu" and velocity in cm/sec.

HOWARD A. CHINN  
*Columbia Broadcasting System*

• • •

### Rectifier

W. K. H. Panofsky and Charles F. Robinson have brought to the attention of the editors several errors in their article "Graphical Solution of Rectifier Circuits" which was published in the April 1941 issue of ELECTRONICS. Please note that the following corrections should be made.

Page 42, column 3, line 23—Substitute "condenser" for "filter drop".

Page 109, line 9—Substitute  $\omega'$  for  $\omega^1$ .

line 28—Substitute  $L_p$  for  $L\rho$ .

line 29—Substitute  $L'$  for  $L^1$ .

line 31—Substitute  $\omega'$  for  $\omega^1$ .

Figure 2, caption—Substitute "charging interval" for "charge".

Figure 6, caption—Delete "for cases where the rectifier resistance is appreciable".

• • •

### SAHARA DESERT BROADCASTING STATION



The broadcasting station Borj Reggan, located in the middle of the desert, is important in keeping up trans-Sahara traffic. It is in permanent contact with airplanes flying over Africa and with all trans-Sahara buses



# THE INDUSTRY IN REVIEW

## News

♦ Further steps in the organization of a nationwide network of frequency modulation broadcast stations were taken recently when the board of directors of The American Network, Inc., met in New York City and elected permanent officers. The group's new president is John Shepard, 3rd, head of The Yankee Network in New England and also president of FM Broadcasters, Inc., a non-profit frequency modulation trade organization which is apart from The American Network, Inc. Other officers include Jack Latham, former advertising man, as executive vice president; Herbert L. Pettey of WHN as secretary-treasurer; and Walter J. Damm, *The Milwaukee Journal*, as vice-president. Some forty-two groups are now included in this organization which hopes in time to lead to the actual operation of a coast-to-coast frequency modulation web on a co-operative basis. Among matters decided upon at the New York Meeting was the adoption of a standard rate card structure, the representation of member stations in spot sales, and the establishment of a uniform discount structure.

♦ Men with degrees in electrical engineering or physics are wanted by the Army and Navy to study and operate high-frequency equipment. The Army wants men 21 to 36 years old, unmarried and without dependents, and offers them commissions as Second Lieutenants. The Navy wants men 21 to 45 years old, married or single, and offers them commissions in ranks from Ensign to Lieutenant-Commander. Applications should be sent to George W. Bailey, Chairman, Radio Section, Office of Scientific Personnel, National Research Council, 2101 Constitution Ave., Washington, D. C.

♦ The F. J. Stokes Machine Company, Philadelphia, Pa., has recently completed construction at its Tabor Road plant, of a new brick and concrete addition. The additional space will be used for the manufacture of completely automatic molding machines and other equipment for the plastics industry . . . A portable million-volt artificial lightning generator has been given to the University of Colorado by the General Electric Company. It will be used to test the effect of high altitude on insulation and for other research.

♦ D. F. Zanuck, Chairman of the Research Council of the Academy of Motion Picture Arts and Sciences, announced the appointment of a subcommittee to prepare definitions for performance characteristics of sound recording systems and theater sound

reproducing systems. Thomas T. Moulton of Samuel Goldwyn Studios is Chairman of the subcommittee . . . The appointment of William J. Halligan, President of The Hallicrafters Company to the Chicago Commission on National Defense has been announced by the Mayor of Chicago.

♦ Columbia Recording Corporation reports that 1940 showed a seventy-five per cent increase in sales of recordings over 1939 . . . Beginning immediately, the extensive resources of the General Electric Company normally concerned with the research and development of radio and television receivers and electron tubes, will be devoted in a large measure to vital defense production of an electronic nature for which a sudden need has arisen . . . A new use of a plastic part to replace aluminum has been found by the General Electric Plastics Department, Pittsfield, Mass., in the development of a plastic pulley sheave. The first application has been installed on wire enamelling machines and has been found to have several advantages over aluminum.

♦ The forty-fifth annual meeting of the International Municipal Signal Association will be held at the Hotel Jefferson, St. Louis, Mo., on September 29th, 30th, October 1st, 2nd. T. R. Fowler, Chief Electrical Engineer, City Hall, St. Louis, is general chairman of the Convention Committee. Technical papers and discussions will cover the installation, operation and maintenance of municipal fire alarm systems, traffic signals, police telegraph, radio communication and related systems and equipment.

♦ Fred W. Kranz, Ph. D., Works Manager of the Sonotone Corporation, manufacturers of electrical hearing aids, Elmsford, N. Y., has been made a vice-president of that firm . . . The Solar Manufacturing Corporation announces the return to their organization of Sylvan A. Wolin as Sales Promotion Manager . . . Distinction for the men behind the scenes in radio broadcasting comes to the engineers in charge of the KGO transmitter, Oakland, Cal., in the form of General Electric Company's national merit award for the least lost time through technical failures during the year 1940.

♦ It was announced that Charles A. Coffin Fellowships have been awarded seven graduates of as many colleges and universities by the General Electric Company. These Fellowships, granted annually, enable outstanding graduates to continue or undertake research work in educational institutions either in this country or abroad. The fields in which awards are made include electricity, physics and physical chemistry.

♦ Chosen the outstanding New England engineer of the year, William H. Pratt, a retired consulting engineer of the meter division at General Electric's Lynn Works, became the first recipient of the New England Award at the annual banquet of the Engineering Societies of New England, Inc. . . . Lieut. Maurice B. McCullough, S. C., has concluded the course of instruction at the Army Industrial College in Washington, D. C., and has been assigned to duty in the Signal Corps Procurement District of New York, Brooklyn, N. Y. . . . Alden Products has consolidated their Pawtucket, R. I., and Brockton plants. They are now located in newer and larger quarters at 117 Main Street, Brockton, Mass.

♦ Dr. Ernst F. W. Alexanderson, consulting engineer of General Electric Co., well known for his contributions to radio, television, and power, received this year's Schenectady Advertising club's annual award. This honor is conferred on an outstanding local person through whose accomplishments Schenectady has received unusually favorable publicity . . . Measurements Corporation has changed its location. It is now on Intervale Road, Parsippany, N. J. . . . The Elastic Stop Nut Corporation, Union, N. J., has doubled the floor space of the plant it built only a year ago . . . Columbia Broadcasting System's new transmitter for WABC is nearing completion on Columbia Island, a mile off New Rochelle, N. Y., in Long Island Sound. Two 25-ton steel-armored marine cables, each 8,000 feet long are used to link the transmitter to the mainland . . . J. M. Howell has succeeded E. D. Spicer as manager of the Schenectady Works of the General Electric Company. Mr. Spicer has been advanced to the post of assistant to the vice-president in charge of manufacturing . . . The Board of Directors of the American Radio Relay League has reaffirmed its 1940 appointment of George W. Bailey, president of ARRL, to act on behalf of the board in all matters of an urgent or emergency nature. The special "defense fund" of \$10,000 appropriated for use in carrying out this assignment was also reaffirmed . . . William F. Seeman, District Sales Manager of the Solar Manufacturing Corporation, has recently been elected to the board of directors . . . Almost 2,500 new f-m receivers were sold during April . . . The Hygrade Sylvania Corporation is building a new half-million dollar fluorescent lamp plant in Danvers, Mass. When completed, all fluorescent lamp manufacturing activities will be transferred from the Salem plant, and permanently established in Danvers . . . Leonard F. Cramer is now Sales Manager of the Instrument and the Video Equipment Divisions of the Allen B. DuMont Labs. Inc.

# Save trouble time and money

with the aid of this  
practical radio  
engineering  
help



1. 945 pages of carefully selected, accurate data—charts, tables, circuits, diagrams, formulas.
2. Covering all the most needed subjects for engineers, from fundamentals to specialized applications.
3. Every section prepared by one or more specialists, to assure you dependable, expert answers to your problems in design and practice.

Just Out

## Enlarged, Up-to-date, 3rd Edition RADIO ENGINEERING HANDBOOK

HERE is a book that gives the radio engineering profession its own handbook, comparable to the standard handbooks available in other fields of engineering. It conveniently presents a great deal of constantly needed reference material covering all fields and aspects of radio engineering—concise, dependable, arranged in easy-to-get-at form. To meet the greatest and most lasting needs in such a rapidly developing field as radio, material has been chosen carefully for its importance to the practicing engineer. With the deletion of obsolete material and addition of material on important new developments, this new third edition brings you:—

- new data on crystal control circuits, ultra-high frequency apparatus, modulation systems, audio-frequency transformer design, vibrator power supply, long-line oscillators, etc.
- completely rewritten sections on aircraft radio, television, detection, loud speakers, facsimile, oscillators, etc.
- revision throughout to make the book as useful as possible in modern practice.

FOR 10 DAYS' FREE EXAMINATION

mail this coupon

McGRAW-HILL BOOK CO., INC.  
330 W. 42nd St., N. Y. C.

Send me Henney's Radio Engineering Handbook for 10 days' examination on approval. In 10 days I will send you \$5.00 plus few cents postage or return book postpaid. (We pay postage on orders accompanied by remittance.)

Name .....  
Address .....  
City and State .....  
Position .....  
Company ..... L 7-41  
(Books sent on approval in U. S. and Canada only.)

## Literature

**Selector Catalog.** The 1941 revision of a 64-page catalog "Quick Selector" is announced by Westinghouse Electric and Manufacturing Company, Department 7-N-20, East Pittsburgh, Pa. The catalog aids in the selection of electrical equipment for motors and lighting or feeder circuits. Subjects covered are safety switches, No-fuze breakers, multi-breakers, panel boards, motor controls and motors. Revisions include equipment additions, price changes, and up-to-date application data, as well as electrical ratings, physical dimensions, and circuit diagrams.

**Glass Pumps.** Bulletin 336 available from Nash Engineering Company, South Norwalk, Conn., describes and illustrates pumps made of Pyrex brand heat and shock resisting glass developed in conjunction with Corning Glass Works. Sizes include 1½ x 2 inch pumps and the newer ¾ x 1 inch pumps. The pumps are for use in small installations and for pilot plant and laboratory requirements.

**Non-Metallic Materials.** Bulletin GF-13 available from Continental-Diamond Fibre Company, Bridgeport, Montgomery County, Pa., covers five basic types of non-metallic materials which will help designers and production men to determine whether or not they can be used to replace materials formerly used which are now becoming scarce. These materials (manufactured by Continental-Diamond) include Dilecto, Diamond Vulcanized Fibre, Micabond, Celoron and Vulcoid.

**Folders.** Several folders are available from Howard Radio Company, 1735 Belmont Avenue, Chicago, Ill. Folder No. 105 lists a complete line of replacement chasses, including frequency modulation and home recorders. Folder No. 106 includes metal and paper base recording discs and needles. Folder No. 104 includes a complete line of communication receivers.

**Signalling Synchronous Motor Timers.** The Industrial Timer Corporation, 109 Edison Place, Newark, N. J. have available bulletin A-17 which describes their new BH Series (BHD and BHR) signalling synchronous motor timers. A number of applications for the timers are given, as well as notes on remote control apparatus. Four circuit diagrams showing various wiring set-ups and output contacts are included.

**Radio Dictionary.** For ten cents a copy of "A Dictionary of Radio Terms" may be had from Allied Radio Corporation, 833 West Jackson Boulevard, Chicago, Ill. It is a 36-page book and contains over 800 commonly used words in radio, electronics and television fields. The book was compiled by the technical staff of Allied Radio and was edited by L. O. Gorder, Professor of Radio Engineering at Chicago Technical College.

**Self-Locking Nuts.** Elastic Stop Nut Corporation, 2330 Vauxhall Road, Union, N. J., have available a 4-page bulletin which illustrates the various types of nuts produced by them, typical fastening problems solved, and describes how the nuts work and why, and gives reasons for using these nuts.

**Transmitting Tube Guide.** RCA's latest transmitting tube guidebook is now available from all RCA Tube and Equipment Distributors, or it may be obtained from RCA Commercial Engineering Section, Harrison, N. J. It contains data on 69 tubes, and 150 circuits which include constructional information on five transmitters. The price is 25 cents a copy.

**Condensed Catalog.** Switches, service equipment, lighting panels, switchboards, and miscellaneous units manufactured by the Bull Dog Electric Products Co., 7610 Jos Campau Avenue, Detroit, Michigan, are covered by condensed catalog No. 411.

**Replacement Guide.** "Replacement Guide to Battery Operated Instruments" is the title of a booklet published to furnish help for radio servicemen. Copies may be had from the Burgess Battery Company, Dept. EL-1, Freeport, Ill.

**Resistor Bulletin.** Various types of vitreous enameled resistors are described in a general bulletin published by Lectrohm, Inc., 5133 W. 25th Place, Cicero, Ill.

**Pin Hole Detector.** A pin hole detector for finding holes in sheet metal is a recent development of the Westinghouse Electric and Manufacturing Co., East Pittsburgh, Pa. The light source, phototube housing, control unit, and pertinent technical data are discussed in a leaflet (No. 18-320) which can be secured by writing to Dept. 7-N-20.

**Insulating Varnish Manual.** This is a 34-page guide to the proper selection and application of insulating varnishes. The subject matter describes the characteristics, uses, applications, and types of insulating varnishes, paints, and enamels made by the Irvington Varnish and Insulator Co., Irvington, N. J. The book is illustrated with pictures, charts, and useful tables, and a cross-index is included for quick reference.

**Neon Sign Machinery.** A bulletin covering its line of neon sign machinery and accessories is available from the Callite Tungsten Corp., 544 39th St., Union City, N. J. The booklet covers completely self-contained units, and accessories to meet every need of the neon sign manufacturer.

**Fuses.** "Good-bye to Fuses", a booklet describing Multi-breakers, a recent development designed to take the place of fuses in the home or plant may be secured from Cutler-Hammer, Inc., 243 North 12th St., Milwaukee, Wisconsin.



## New Products

### Tester

TRIUMPH MANUFACTURING Company, 4017 West Lake Street, Chicago, announces model 323 test set which is a pocket size, general purpose instrument for radio and electrical measurements.

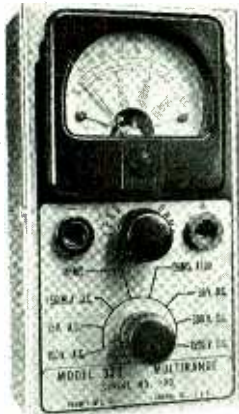

It has high sensitivity and is designed for alternating or direct current instruments. The panel is of stainless steel with a welded steel case which is fully insulated. The size of the instrument is 2 3/4 x 5 1/4 x 1 1/4 inches. Shipping weight is two pounds.

### Electronic Multitester

FEATURED IN THE 1941-1942 LINE of radio test equipment offered by Radio City Products Company, 88 Park Place, New York City, is Model 661 electronic multitester. This instrument combines the functions of a vacuum-tube voltmeter, vacuum-tube ohmmeter, and vacuum-tube capacity meter in one unit.



It has a total of 26 ranges for measuring a-c and d-c voltages up to 6000 volts; a resistance measuring range from 0.1 ohm to 1000 megohms; and a capacity range from 30  $\mu$ f to 1000  $\mu$ f. The high input resistance (160 megohms on the high ranges and 16 megohms on the lower ranges) insures negligible circuit loading, and makes this instrument adaptable for testing during actual operation.

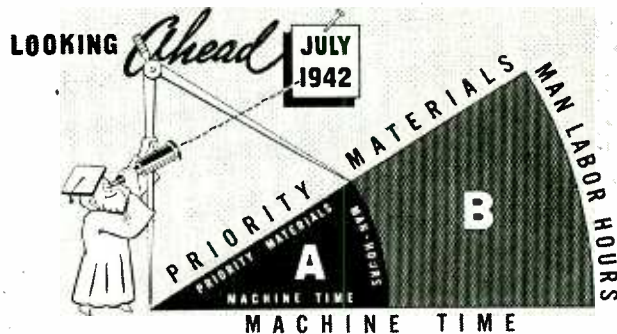

## RELAYS SHRINK the Production Triangle!

★ Now is the time to draw-in the line on materials—machine operations—man labor hours . . . three costly, hard-to-get "ingredients" that complete the production triangle. Where to pare?

Begin with your present method of control. If not electrical, you're probably doing an unintentional job of waste (Area "B" above) that may find you "hard-put" another year hence.

### RELAYS by GUARDIAN . . .

Let Guardian Electric Engineers design your control with Relays by Guardian. Immediately, you scale down materials, machine time and man labor hours (Area "A" above) in triple-thrifty proportion.

**YOU CAN SWITCH** to Guardian Electric Controls quickly . . . easily. A single unit or combination of Relays, Switches, Solenoids by Guardian can be assembled into a production SAMPLE from \*7,146 standard Guardian parts. Then ANY QUANTITY as you want them, delivered fast! Send your blueprint for cost-free engineering advice.

FREE—Get New 1941 Catalog "E" Today. Write

**GUARDIAN ELECTRIC**

1625 West Walnut Street



Chicago, Illinois

LARGEST LINE OF RELAYS SERVING AMERICAN INDUSTRY



Series BK—16 Relay. Built to minimum tolerances and the most exacting requirements in production quantities for the U. S. Signal Corps.

\*Inventory Count Jan. 1, 1941



## PERMANENT MAGNETS

ALL SHAPES — ALL SIZES  
FOR ALL PURPOSES

Stamped, Formed, and Cast; Chrome, Tungsten Cobalt and **ALNICO\*\*** (cast or sintered) under G. E. license.

### THOMAS & SKINNER

STEEL PRODUCTS COMPANY  
1116 E. 23rd STREET INDIANAPOLIS, INDIANA

Laminations for Radio Transformers — Tools  
Dies — Heat Treating — Stampings

**40 YEARS EXPERIENCE**

No chance for Argument -  
No NEED of any



Wire wound RESISTORS by Instrument Resistors, Inc., perform with absolute dependability wherever they



TYPE ML 1 Watt

are used. ● Our advanced winding methods cut your costs and speed up production. We stop delivery delays before they occur! ● Consult Instrument Resistors, Inc. You'll get the exact units you want - WHEN you want them. Catalog upon request.

INSTRUMENT RESISTORS, INC.

Little Falls, N. J.



A Precision Crystal  
Secondary  
**FREQUENCY STANDARD**  
THAT HAS BEEN  
"Designed for Application"

A precision frequency standard capable of being adjusted to WWV or some other primary standard and putting out uniformly accurate calibrating signals with 10, 25, 100, 1000 KC intervals. Uses the new GENERAL ELECTRIC No. 18A 1000 KC crystal having a frequency temperature coefficient of less than one cycle /Mc/C°. The crystal is sealed in Helium in a standard metal tube envelope. The self-contained AC power supply has VR150-30 voltage regulator tube. In addition to oscillator, multivibrators, and harmonic amplifier, a built-in mixer with phone jack and gain control on panel is incorporated.

**JAMES MILLEN**  
150 EXCHANGE ST.  
  
**MFG. CO. INC.**  
MALDEN, MASS.

## NO ENGINEER

whose work takes him into the field of sensitive electrical devices can say—today—that he is thoroughly grounded unless he "knows his electronics."

Because electronic circuits more and more are getting into industrial work as an automatic hand, an automatic eye, a new means of generating heat, etc., etc., they have become the background for a new cycle of industrial progress.

Are you trying to get along without **ELECTRONICS?** Better subscribe today!

## Sound System

ALLIED RADIO CORPORATION, 833 West Jackson Boulevard, Chicago, Ill., announces a 50-watt De Luxe sound system incorporating the "cardiod discrimination principle" which is a system designed to reduce feedback and noise pickup while adding greater volume and wider pickup. Known as the Knight 50-watt system, the unit is compact and portable and is designed to cover most public address requirements, with additional reserve power. It consists of: a De Luxe amplifier (less phono top and VI meter) in a portable case measuring 22½ x 17½ x 17½ inches with a compartment for cables, etc.; a Shure Uniplex cardioid microphone with a 25-foot cable and a plug, mounted on a take-down floor stand; two Knight Safused heavy-duty 12-inch PM dynamic speakers with 30-foot cables and plugs, in a split carrying case; and tubes.



The output is 50 watts usable power (68 watts peak). Hum is inaudible (63 decibels below the rated output); output impedances are 2, 4, 6, 8, 250 and 500 ohms on the selector switch, designed for PM speakers; there are six input channels, with four for high impedance microphones, and two for the overall control; tone controls include individual attenuation and boost types for bass and treble; the gain from the microphone is 135 decibels, and from phono it is 80 decibels; frequency response is 40-10,000 cycles per second; drain is 230 watts. The unit utilizes four tubes, and is fused for operation on 110-120 volts, 60 cps. The overall size is 19½ x 14½ x 11½ inches.

## Micro Die Duplicating Bender, and Bench Shear

O'NEIL-IRWIN MANUFACTURING Company, 316 Eighth Avenue South, Minneapolis, Minn., has available machines for duplicating nominal quantities (one thousand pieces or less) of metal pieces and stampings without the preparation and expense of dies or die sets.

The Standard Micro Die Duplicating Bender No. 2 will economically duplicate ductile materials of solid cross section to shapes and outlines of regular or irregular radii to tolerances achieved with forming dies.

Ductile materials of open or irregular cross section may be economically duplicated with the No. 2 unit by the addition of simple conversions readily made from stock materials. Shop made conversions will adapt this unit for rapidly forming round or square tube, angle, channel, half-round or flat wire and strip stock formed on edge and vertically. The design of this bender will accept a large variety of conversions, clamps, gauges and material length guides for accurately forming any materials to any shape or degree within their expansion and contraction limits. For rapidly receiving and delivering materials an automatic nose efficiently functions for either right or left hand direction operating. The time required to change operating direction is less than one minute.

This standard machine may be located in any one of 12 convenient positions for bench or operating position mounting. Three additional operating positions may be gained each time one additional hole is drilled in the base. Heavy hold down lugs of ample capacity securely retain the unit in its operating position. All contact parts are of hardened and heat treated steel.

The Micro Die Duplicating Bender No. 1 is a basic bending machine. It will duplicate many varieties of metal pieces and substitute for blanking or forming dies, eliminating in a great many cases, the expense of making dies or die sets. The range of contour bending and die duplicating operations possible is only limited by the expansion and contraction limits of the material being formed. The Micro Die Duplicating Bender will receive without alteration to its design, simple conversions for forming angle, channel, rod, round or square tube, round, square, half-round or flat wire and strip stock (on edge and vertically) and any other ductile materials. Minimum set-up time is required for conversions which can readily be made from regular stock materials.

The Micro Bench Shear is a precision shear for work between the heavy floor type foot operated shear and the small thumb and finger operated tinsmiths shear. It can be accurately set for die duplicating work, trimming metal stampings and workings stock size materials. The design of the shear permits close observation of work at all times. The hand operated lever provides a sensitive cutting control. It also gives machine stability for accurate light shearing. Either right or left hand operation is possible.

## 45-Volt "B" Battery

A NEW 45-VOLT "B" battery for portable radios which has more than double the capacity of a conventional battery of the same volume has just been introduced by the Ray-O-Vac Company, Madison, Wis. Known as type P-7830, it combines ample shelf life with the ability to deliver long "in-use" service. Its size is about one half that of the standard V30B type unit.



## Portable Disc Recorder

PORTABLE DISC RECORDING equipment for cutting instantaneous recordings both in radio studios and on remote locations, has been announced by RCA Manufacturing Company, Camden, N. J. The unit is compact and is a complete recording channel, with the exception of a microphone. It consists of a turntable, a record cutting attachment, and an amplifier and loudspeaker unit. The turntable and the amplifier-speaker unit may be used together as a record player.

The turntable unit consists of a 16-inch turntable, rim-driven by a synchronous motor. The use of two rubber-tired driver wheels between the motor shaft and the turntable rim, eliminates slippage. The off-on switch disconnects the power and, at the same time, releases both driver wheels to prevent flats from developing in the rubber. The turntable operates at 78 and 33 1/3 rpm the speed change being made by turning a knob. The unit is equipped with an RCA high-fidelity combination pickup and tone arm with permanent diamond point stylus and has a uniform frequency response between 30 and 10,000 cps. This



pickup reproduces with laterally and vertically cut records and several filters are provided for properly reproducing the particular kind of record being used. A convenient switch permits selection of the filter desired.

The driving motor is rubber shock mounted from the motor board, reducing rumble below audibility. The recording attachment is equipped with a spiralling handwheel, a 6000 cycles per second cutting head and a unique cutter-dropping mechanism which is designed to prevent stylus or record damage. The amplifier and loudspeaker unit contains a 12-watt amplifier which has a gain of 105 decibels, and includes a built-in alternating current power supply. It has a frequency response of plus or minus 2 decibels from 30 to 15,000 cycles per second, a noise level which is 60 decibels below the signal, and a distortion content of less than 3 per cent r.m.s. at full output when measured at any frequency between 50 and 7000 cycles per second. A complete signal stage preamplifier with input and output transformers is included as a part of the amplifier.

Mounted in the removable lid are two "accordian edge" loudspeakers enclosed in a sealed compartment for cone loading and low frequency re-

sponse. A cut-out is provided in the front panel for the installation of a meter for monitoring the recording level. A monitoring headphone jack, a power switch and a fuse are also located on the front panel for ready accessibility. Available accessories are a 10,000 cycles per second cutter-head, an automatic equalizer, and outside-in feed screw.

## Line Voltage Regulator

CLAROSTAT MANUFACTURING COMPANY, 285 North Sixth Street, Brooklyn, N. Y., announces a line voltage regulator which acts as lightning protection for radio sets in localities subject to severe electrical storms. By inserting the automatic line voltage regulator between the set and the outlet, the heavy induced charge is stopped short of the set, (sometimes at the cost of a melted regulator serving as a fuse). A usual lightning arrester is used to protect the set against any lightning bolt in the immediate vicinity of the aerial. The regulator also serves to maintain the set voltages within satisfactory and safe limits for good reception.

## Electric Thickness Gauge

A NEW TYPE OF ELECTRIC GAUGE for measuring the thickness of non-magnetic metals when only one side is accessible is a recent development of the General Electric Company of Schenectady, N. Y. The gauge consists of a bridge circuit, voltage amplifying equipment, and an indicating instrument. The bridge circuit is made up of two inductances with U-shaped cores and a differential transformer. The inductances serve as a gauge head and an adjustable balancing head. When the gauge head is placed against a non-magnetic metal, it sets up eddy currents in the metal. This changes the impedance of the head and affects the circuit bridge balance. The effects of these eddy currents upon the circuit bridge as shown by the deflections on the indicating instrument are plotted upon a master curve for known thicknesses of a specific metal within the desired thickness range. Then the gauge head is placed against an unknown thickness of the same metal and the deflection is read and compared with the master curve reading. The contour of the unknown piece must be the same as the one from which the master curve was plotted. The higher the resistivity of the metal the greater the thickness that can be measured. Thickness of brass sheets can be measured up to 1 1/2 inches, and copper, which has a lower resistivity, can be measured only to 3/4 inch. The gauge was originally developed to measure the thickness of hollow aluminum airplane propellers.

## PROFESSIONAL SERVICES

(Rates on Application)

### JOHN C. BATCHELOR

INDUSTRIAL PHYSICISTS-ENGINEERS

Specialists in industrial, technical and marketing investigations for manufacturers and bankers, on products being considered for production and financing.

100 E. 42nd Street New York City

### DUDLEY B. CLARK

Consulting Engineer

Industrial Tube and Circuit Design.  
Electronics as applied to Metal and Chemical Industries.

Research Laboratories and Shops  
Palm Springs Calif.

### ELECTRICAL TESTING LABORATORIES

Characteristics of Vacuum Tubes  
Tests of photo cells, glow lamps, crater lamps.  
Tests of electronics and optical devices  
East End Avenue and 79th Street  
New York, N. Y.  
Phone: Butterfield 8-2600

### HAROLD J. McCREARY

Mem. A.I.E.E. & W.S.E.

Consulting Engineer

Laboratory Facilities  
Research Electronics  
Development Television  
Design Radio  
Factory Practice Railroad Signaling  
Patent Studies Telephony  
105 W. Adams St. Phone STate 4003 Chicago, Ill.

### JOSEPH RAZEK, PH.D.

Consulting Physicist

Electrical and Mechanical Engineering Problems  
Instruments and Control Devices Electronics  
Specialist in Colorimetry, Spectrophotometry and  
Industrial Color Control

Laboratory and Shop Facilities  
430 Greenview Lane Llanerch, Pa.

### F. H. SHEPARD, JR.

CONSULTING ENGINEER  
ELECTRONIC APPLICATIONS

Specializing in:  
Industrial Control Special Amplifier Design  
Follow-Up Devices Photoelectric Applications  
Radio and Carrier Operated Remote Control  
6167 Cedar Ave., Merchantville, N. J.  
Telephone Merchantville 1111

## When time is short,

put the solution of some of your design or production problems up to some specialized Consultant whose advertisement appears on this page. His broad experience may save you months of costly experimentation.

Departmental Staff,

**ELECTRONICS,**

330 West 42nd St., New York City

# Specify CETRON ELECTRONIC TUBES

**AND BE SURE OF  
PERFORMANCE  
RELIABILITY  
QUALITY**

The list of users of Cetron products reads like "Who's Who" of America. Let us help you solve your tube problems with Cetron Electronic Tubes.

Write today

**CONTINENTAL ELECTRIC CO.**

Merchandise Mart  
Chicago, Ill.

Plant  
Geneva, Ill.

## JONES 500 SERIES PLUGS and SOCKETS

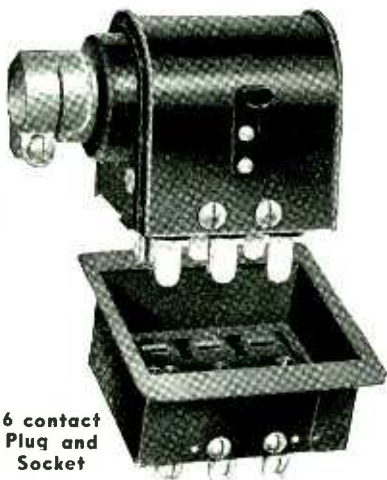

6 contact  
Plug and  
Socket

5000 volts and 25 amperes. Fulfills every electrical and mechanical requirement. Polarized to prevent incorrect connections. Easy to wire. Sizes: 2, 4, 6, 8, 10 and 12 contacts. Thousands of uses. Write for Bulletin 500 today.

**HOWARD B. JONES**  
2300 WABANSIA AVENUE,  
CHICAGO ILLINOIS

## Communications Receiver

SEVERAL INTERESTING FEATURES are embodied in the new models EC-3 receiver made by the Echophone Radio Corporation, 201 East 26th Street, Chicago, Ill. They include a tuned r-f stage on all bands, continuous coverage from 545 kc to 30.5 Mc, crystal filter, four degrees of selectivity, crystal phasing control for interfering signal reduction, automatic noise limiter with



switch, phone-tip jacks and speaker-phone switch, beat-frequency oscillator with variable pitch control, external speaker in matching cabinet, electrical band spread with calibrations for four ham bands, but is usable anywhere in the receiver's tuning range, and indirectly illuminated dial scales. It may be operated from both a-c and d-c 115-volt lines.

## Sapphire Needle for Low-pressure Pickups

ELECTROVOX COMPANY, 424 Madison Avenue, New York City, announces the WN-55 Walco sapphire needle for low-pressure pickups. The stylus has been developed in conjunction with the engineers of several large radio-phonograph manufacturers. The specifications include a genuine sapphire point mounted in a straight duralumin shank. The shank has two parallel in-cut flats ground near the tip to provide

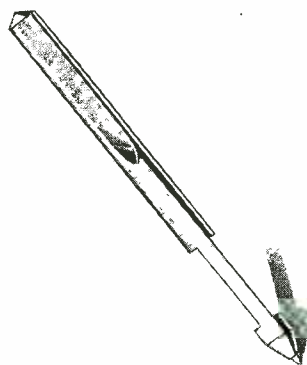

a lateral flexibility which eliminates needle talk and minimizes surface noise. The shank also has a flat on its upper extremity for the set screw, to expediate correct positioning in the pickup when used as a replacement. The needle is specifically designed for pickups having needle pressure of 2 ounces or less. At one ounce pressure, the needle is rated by the manufacturer to give approximately 12,000 playings.

## Varnish-Saturated Tubing

THE GENERAL ELECTRIC APPLIANCE and Merchandise Department, Bridgeport, Conn., is manufacturing a new line of varnish-saturated tubings for insulating bare wires or for increasing the dielectric strength of insulated wires. The tubings are made of closely woven cotton yarns which are thoroughly impregnated with insulating varnishes, the liquid penetrating all through the tubing instead of forming veneer laminations on the surface only. The tubings are very flexible, have a high dielectric strength, and a low moisture absorption. Three grades are available, in sizes 20 to minus 1½, either black or yellow.

## Midget Latch-in Electrical Reset Relay

A NEW MIDGET-SIZE mechanical latch-in electrical reset relay has been announced by Struthers Dunn, Inc., 1335 Cherry St., Philadelphia, Pa. Mounted on a base measuring 3¼ x 2¾ inches, the new relay has a non-inductive load contact rating of 110 volts, 6 amperes, or 220 volts, 3 amperes alternating current; and 115 volts, 1 ampere, direct current. Coils may be obtained to operate from 6 to 220 volts alternating current, at approximately 4 watts each; or 2 to 230 volts direct current, at approximately 2 watts each. A series resistor is used in the coil circuits when direct current voltages above 90 volts are specified.

The new relay is known as type ABB-IN. It is available in almost any required contact arrangement and may be used with 3-wire thermostat control, or for interlocking purposes on public utility equipment, or can be adapted to special requirements. A catalog listing this new development as well as larger size Dunco relays is available from the manufacturer.

## Radial 360-Degree Loudspeaker

A NEW "BULL" TYPE of radial 360° loudspeaker known as model 2RYR is available from University Laboratories, 195 Chrystie Street, New York City. The unit has high handling capacity. It is of the long exponential reflex driver unit type which is designed for high efficiency. A special multiple acoustic throat is used to adapt the high power driver units to the reflex radial horn. The driver units are housed in a mushroom-shaped, weather-proof cover. Power handling capability of the radial speaker is 50 watts. The loudspeaker is for use with high power chime systems or paging and announcing systems, and for all types of work where a single speaker is to be used to cover very large areas and crowds of people, such as circuses, ball games, etc. The bell diameter is 26 inches, the height is 32 inches.



# CONTACTS

FOR THE FIELD OF ELECTRONICS

Lubricated Contacts

**WRITE FOR CATALOG**

## SEVEN LEAGUE BOOTS

A modern, streamlined delivery service (via our own delivery cars) brings you supplies PDQ and in tip-top shape. You can trust us to fill your orders promptly and efficiently. Remember Terminal's two conveniently located stores!

**TERMINAL RADIO CORP.**  
68 W. 45th St. • 80 Cortlandt St., N.Y.C. • V.A. 6-5050



**SIGNICO**

## SIGNAL & INDICATOR PILOT LIGHTS

for all electrical devices.

WRITE FOR CATALOGUE showing a complete line of assemblies for all purposes.

**SIGNAL INDICATOR Corp.**  
140 CEDAR ST. NEW YORK, N. Y.



## We manufacture a complete line of equipment

SPOT WELDERS, electric, from 1/4 to 500 KVA  
TRANSFORMERS, special and standard types  
INCANDESCENT LAMP manufacturing equipment  
FLUORESCENT TUBE MAKING EQUIPMENT  
ELECTRONIC EQUIPMENT, vacuum pumps, etc.  
WET GLASS slicing and cutting machines for laboratory use  
GENERAL GLASS working machines and burners  
COLLEGE GLASS working units for students and laboratory

**EISLER ENGINEERING COMPANY, CHAS. EISLER, Pres.**  
751 So. 13th St. (near Avon Ave.) Newark, New Jersey



QUALITY ABOVE ALL

**SOLAR**  
CAPACITORS

Write for Catalog  
**SOLAR MFG. CORP.**  
BAYONNE, N. J.

Just say:  
"Information,  
please"

whenever you need products or services not advertised in a particular issue of this magazine.

Each issue is only part of the complete service we are organized and glad to render to reader and advertiser, alike. We want you to consider Electronics your primary source of information in this field.

Departmental Staff,

**ELECTRONICS.**  
330 West 42nd St., New York

## CRYSTALS by HIPOWER

The Hipower Crystal Company, one of America's oldest and largest manufacturers of precision crystal units, is able to offer the broadcaster and manufacturer attractive prices because of their large production and the exclusive Hipower grinding process. Whatever your crystal need may be, Hipower can supply it. Write today for full information.

**HIPOWER CRYSTAL CO.**

Sales Division—205 W. Wacker Drive, Chicago  
Factory—2035 Charleston Street, Chicago, Ill.

## ENGINEERS!

HERE'S YOUR COMPLETE  
Source of Supply

ALL STANDARD RADIO and ELECTRONIC EQUIPMENT IN STOCK!  
There's NO WAITING—NO DELAY  
at SUN!

Call BARCLAY 7-7647 for PROMPT Service!

**SUN RADIO CO.**  
212 FULTON ST.  
NEW YORK, N. Y.

## MICROMETER

FREQUENCY for checking transmitters.  
from 1.5 to 56 mc.,  
within 0.01 per cent.

**LAMPKIN LABORATORIES**

—Bradenton, Fla., U. S. A.—

**COILS** Our facilities permit production of practically all types of coil windings . . . paper interlayer sections, bobbin wound, etc.

**TRANSFORMERS** Audio, power, filament and low voltage transformers and filter chokes for all industrial applications.

**REACTORS for FLUORESCENT LIGHTING** A complete line of fluorescent ballasts and reactors approved by Underwriters Laboratories.

WE INVITE YOUR INQUIRY

**JAMES W. DOYLE, INC.**

311 N. Desplains St. Chicago, Ill.

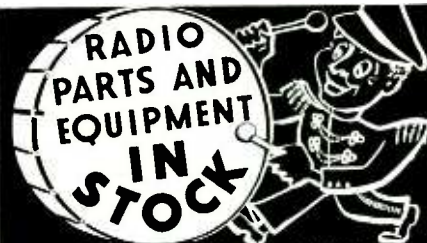

Call BRYANT 9-1946 for SERVICE!  
**HARVEY RADIO CO.**  
Conveniently located at Times Square  
103 W. 43 ST. • NEW YORK, N. Y.

## FINE RIBBONS

of Tungsten and Molybdenum  
Molybdenum in widths .006" to 1"  
in thickness to .0005"  
Tungsten Ribbon to specification

**H. CROSS**

15 Beekman St. New York

## Marine Radio Telephone

THE WESTERN ELECTRIC Co., 195 Broadway, New York City, has announced a new marine radio telephone known as the 226-D. The new instrument features a quick selection of any one of ten pre-tuned frequencies, quartz crystal control of both transmission and reception, high signal clarity, low noise, and semi-automatic operation. A single control shifts both the transmitter and receiver to any one of ten frequencies. Nine of these are for ship-to-shore conversations, and the tenth is used for ship-to-ship and coast guard communication. All the controls are mounted on the front panel within easy reach. The receiver is of the superhetrodyne type, and embodies the latest developments in circuit design. The 226-D operates on 110 volts a.c. which may be supplied by a rotary converter. Converters are available for operation from 12, 24, 32, or 110 volt d-c ship power supply systems.

## Midget Moulded Capacitors

A NEW LINE OF MIDGET moulded capacitors (type 8) has been put on the market by the Cornell-Dubilier Electric Corp. of South Plainfield, N. J. Moulded in brown bakelite, the size of these capacitors is  $1\frac{1}{2} \times \frac{1}{2}$  inches, the thickness varying from 0.25 to 0.4 inch, depending on the capacity. Standard units are available in capacities from 0.000001 to 0.01  $\mu$ f. Those up to 0.003  $\mu$ f have 500-volt rating (d-c);

above this value the rating is 300 volts. Type 8 may also be had in low-loss yellow bakelite. These capacitors may be obtained on special order with any of the following characteristics: capac-

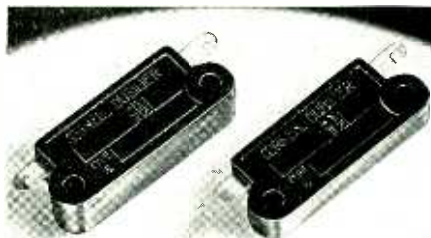

ity tolerance of plus or minus 2 per cent, temperature aged, with salt water immersion seal against humidity, and with d-c ratings of 800 volts.

## Electronic Impulse Timers

A NEW DEVELOPMENT of the Weltronic Corporation, 3080 E. Outer Drive, Detroit, is a line of electronic impulse timers for use in resistance welding work consisting of model 114 which is semi-automatic, and model 57 which is a high speed automatic timer. Both models use electron tubes to interrupt the current long enough to permit cooling of the welding points, and soon enough to prevent material cooling of the sections at the weld. The only moving parts are the arms of the three relays used. These timers simplify welding operations which were extremely difficult heretofore. They make pos-

sible easy welding of heavy sections and large numbers of laminated sections. The semi-automatic timer is adjustable for time "on", "weld", and "cool", and for the number of current interruptions desired. The high speed automatic, in addition to these adjustments has a dial for regulating the "off" time between resistance welds.

## 3-Band Portable Receiver

LEAR AVIA, INC., 30 Rockefeller Plaza, New York City, announces a new portable receiver which covers the aeronautical and broadcast frequencies in three bands: 195-410 kc. (airways and marine radio ranges, weather broadcasts and traffic control), 540-1560 kc. (standard broadcasts), and 2200-6300 kc. (airways communications, including private flying, airlines, coast guard and army and navy aeronautical frequencies). On the ground, it may be operated from its own, self-contained, dry cells or from an a-c or d-c power line. In the air the unit is operated from its own dry cells. Besides a built-in speaker, a headphone jack is provided which automatically cuts out the speaker when headphones are in use. An added feature of this portable is the built-in interphone system which can be used for intercommunication between cockpits. The unit is compact,  $8\frac{1}{2}$  inches high, 12 inches wide, and six inches deep, and weighs slightly over 14 pounds, including the dry cells which are sufficient for 200 hours of operation.

# SEARCHLIGHT SECTION

EMPLOYMENT • BUSINESS • OPPORTUNITIES • EQUIPMENT—USED or RESALE

UNDISPLAYED RATE:

10 cents a word, minimum charge \$2.00.

(See ¶ on box Numbers.)

Positions Wanted (full or part-time salaried employment only), one-half the above rates.

Proposals, 50 cents a line an insertion.

INFORMATION:

Box Numbers in care of our New York, Chicago or San Francisco offices count 10 words additional in undisplayed ads.

Discount of 10% if full payment is made in advance for four consecutive insertions of undisplayed ads (not including proposals).

DISPLAYED—RATE PER INCH:

The advertising rate is \$6.00 per inch for all advertising appearing on other than a contract basis. Contract rates quoted on request.

An advertising inch is measured  $\frac{1}{4}$  inch vertically on one column, 3 columns—30 inches—to a page. E.

NEW ADVERTISEMENTS received by 10 A. M. July 30th will appear in the August issue, subject to limitations of space available.

### POSITION VACANT

Electrical Engineer wanted to design and supervise production of power amplifiers for sound systems and oscillators and other electronic devices for special signalling purposes. Applicant must be thoroughly experienced. Good opportunity.

P-286, Electronics

520 No. Michigan Ave., Chicago, Ill.

### POSITIONS VACANT

LARGE MIDWESTERN radio receiver manufacturer has openings for experienced automotive and household radio receiver design engineers. Applicants should state education, experience and give references. Our own employees know of this ad. P-270, Electronics, 520 N. Michigan Ave., Chicago, Ill.

ENGINEERS, with experience in radio or fluorescent lighting. Location Cincinnati. P-287, Electronics, 520 N. Michigan Ave., Chicago, Ill.

### POSITIONS WANTED

RADIO PATENT EXPERT and Electrical designer, proven merit. My designs have largest sales value of any advertised. R. G. Evans, 3945 Second, Detroit, Mich.

### POSITIONS WANTED

EXECUTIVE now in charge of sales promotion for prominent manufacturer seeks responsible connection with well managed radio or electronic equipment manufacturer concentrating on national defense work. Well regarded by management and employees, considers change only because priorities restrictions prevent full exercise of successfully demonstrated management ability. Graduate E. E., young, 23-year intensive interest in field, 12-year broad commercial background in manufacture of receivers, sound amplifiers, transmitting equipment and electro-acoustic devices. Has had complete responsibility for engineering and sales programs in recent connections. Well known in industry through published writing, engineering society activities, distributor and representative contacts. Experience in patents and license negotiations. Knows costs, project budgeting, sales analysis, production planning. Well equipped to handle contact work with government agencies and prime contact accounts. Expect salary fully commensurate with responsibilities sought. Your reply to PW 288, Electronics, 520 N. Michigan Ave., Chicago, Ill., will bring complete details.

FIRST CLASS Telephone broadcast engineer, desires permanent position with medium sized station of good standing in Western U. S. Married, 30, Protestant, dependable, experienced in design, installation, operation and maintenance as Chief Engineer past five years at Kilowatt Station. Now employed. PW 289, Electronics, 520 N. Michigan Ave., Chicago, Ill.

### DEPENDABLE

#### Used ELECTRONIC TUBE EQUIPMENT

Complete line of used equipment for the manufacture of Radio Tubes, Neon Tubes, Incandescent Lamps, etc. Write for Bulletin showing 25 to 75% savings.

CALLITE TUNGSTEN CORPORATION  
formerly Eisler Electric Corp.  
534 39th Street, Union City, N. J.

### HIGH GRADE USED ELECTRON TUBE MACHINERY

Huge Stock of Every Type and Variety  
KAHLE ENGINEERING CORPORATION  
Specialists in Equipment for the manufacture of Neon Tubes, Radio Tubes, Incandescent Lamps, Photo Cells, X-ray Tubes, etc.

900 DeMott St., North Bergen, N. J.

Don't forget the

### BOX NUMBER

When answering the classified advertisements in this magazine don't forget to put the box number on your envelope. It is our only means of identifying the advertisement you are answering.



# Industrial Electronics

(Continued from page 20)

tainer to forestall the possibility of the cover being thrown away or discarded. Then a lock and key were provided, so that only authorized plant service men, usually from the electrical service and maintenance department, would have access to change tubes or make adjustments. The cast housing (Fig. 9) shows these drastic changes.

Many different standard and semi-standard types of amplifiers and electronic units are housed in this standard container. They range from photoelectric temperature control units, photoelectric flame monitors, conductivity flame monitors, welded tube flaw detectors, trigger units for measuring, and electronic limit switches, to simple vacuum tube and gas tube time delay relays.

A typical chassis, such as that used for electronic time delay relays or for multi-stage phototube amplifiers, is shown in Fig. 10. The weight of the chassis has been materially increased; a rigid system of holding filter condensers and power transformers is employed; and, in general, the equipment matches up with ruggedness that a plant man now expects of electronic equipment.

The standard knock-out box mounted on the side of the cast housing contains the terminal strip, so that various conduits can be piped directly to the unit, without using additional junction boxes in other conduit lines.

Phototube housings of a wide and varied type as well as a large variety of light sources, have received this same treatment, making them rugged and yet pleasing in appearance.

## Standard Light Relays

The first single-stage light relays receiving the press publicity of the electric eye were purchased without question as to their ability to function on the particular job. There were mechanical engineering departments that purchased these \$34.00 units and expected them to do everything from matching colors of seat fabrics to inspection of threads. It

took some time to overcome this setback to the electronic business; it became a matter of personal interview, of obtaining all the details of the particular problem, and then giving a brief discussion of optics and electronics to prove why, for these special jobs, a simple unit would not work.

Several years later many of these units found their way into proper uses, such as starting and stopping conveyors, opening and closing doors, turning on lights; and other simple large light beam interception by a still larger object. The first units were generally crude, hand made, sheet metal units. The circuit usually consisted of a standard phototube, followed by a single amplifier tube, the plate circuit of which operated a telephone type relay. Many units of this type are still on the market, but do not receive as wide acceptance in the industrial field as do the more modern cast aluminum housed units with added features. The early sheet metal housed simple light source and its associated single stage phototube unit are shown in Fig. 11, while Fig. 12 shows the more modern units after adopting cast housings, and a touch of streamlining.

From the foregoing it can be seen that many advancements and improvements have been made in the simple straightforward standard units for industry. But, many special electronic units are continually being built, many in the experimental and design stage before they are ready to go into production machines. Usually, even if it is to be something of a special nature, the production department of the large plants want it the day before it is ordered. These electronic problems, ranging from simple units for measuring, grading and sorting, to complete machines for gapping spark plugs automatically with electronics to do the gauging have given pleasure and headaches in their accomplishment. The concluding portion of this article will be published in an early issue of ELECTRONICS.



## PRODUCTION SHACKLED BY DELAYED SUPPLIES?

You can get quick deliveries of all the Dial and Jewel Pilot Light Assemblies you need if you specify DRAKE! Ample high speed production facilities and supplies assure uninterrupted service for our customers.

Patented features and precision engineering make Drake Assemblies more efficient and dependable. Available in big variety of standard types. Special Assemblies designed to order. You can depend upon DRAKE . . . (world's largest exclusive manufacturers) for the Pilot Light Assemblies you need.



Send for the  
NEW DRAKE  
Catalog!

PILOT LIGHT  
ASSEMBLIES

DRAKE MANUFACTURING CO.  
1713 W. HUBBARD ST. • CHICAGO, U.S.A.

## COILS

Electrical  Windings



A COMPETENT and experienced organization devoted to the design and manufacture of coil windings. Paper interlayer sections—form wound and bobbin wound coils.

Equipped for prompt production on quantity or small orders.

### REPRESENTATIVES

W. A. JORDAN 295 Madison Ave., New York, N. Y.	PARAGON SALES CO. (C. H. Fryburg) 402 Cherry St., Philadelphia, Pa.
GILBERT GISLASON 82 St. Paul St., Rochester, N. Y.	A. J. LOEB SALES CO. 1836 Euclid Ave., Cleveland, Ohio

**MAGNETIC WINDINGS COMPANY**  
Sixteenth and Butler Streets EASTON, PENNA.



# AUDAX

“RELAYED-FLUX”

Microdyne

“The Standard by Which Others  
Are Judged and Valued”

Most important wide-range development since the advent of the pick-up in 1926. The “RELAYED-FLUX” principle makes possible a moving system far beyond anything yet devised . . . capable of reproducing all the fine detail engraved at the original recording—MICRODYNE bears out the contention of scientists that high-fidelity is possible only with a Moving-Inductor system.

- Flat within  $\pm 1\frac{1}{2}$  db to over 10,000 cycles
- Vibratory momentum extremely low
- Absence of distortion
- High stylus compliance
- Low Point-pressure
- Complete with special arm

With or without Jewel Point, the sharp, clean-cut *fac simile* reproduction of MICRODYNE—regardless of climatic conditions—is a marvel to all who have put it to the only test that really counts . . . the EAR test.

Pickup List Prices

**\$12.50 to \$188.00**

HIGH FIDELITY CUTTERS  
List to \$98.00

### WITH OUR COMPLIMENTS

A copy of “PICK-UP-FACTS” is yours for the asking. It answers many questions concerning record reproduction.

**AUDAK COMPANY**  
500 Fifth Avenue New York City

“Creators of High Grade Electrical  
and Acoustical Apparatus Since 1915”

## INDEX TO ADVERTISERS

<b>A</b>		<b>L</b>	
Aerovox Corp. . . . .	76	Lampkin Laboratories . . . . .	87
American Lava Corp. . . . .	2	Lapp Insulator Co. . . . .	9
American Transformer Co. . . . .	10	Lingo & Son, Inc., John E. . . . .	65
Audak Co. . . . .	90	Littelfuse, Inc. . . . .	66
Autocall Co. . . . .	60		
Automatic Electric Co. . . . .	68		
<b>B</b>		<b>M</b>	
Bakelite Corp. . . . .	53	Magnetic Windings Co. . . . .	89
Ballantine Laboratories, Inc. . . . .	61	Mallory & Co., P. R. . . . .	12
Benwood Linze Co. . . . .	70	McGraw-Hill Book Co. . . . .	82
Bliley Electric Co. . . . .	60	Millen Mfg. Co., Inc., James . . . . .	84
Brand & Co., William . . . . .	Third Cover		
Bud Radio, Inc. . . . .	73		
<b>C</b>		<b>P</b>	
Callite Tungsten Corp. . . . .	48	Pioneer Gen-E-Motor Corp. . . . .	62
Cannon Electric Development Co. . . . .	77	Precision Apparatus Co. . . . .	75
Capitol Radio Engineering Institute . . . . .	66	Presto Recording Corp. . . . .	73
Carborundum Co., Global Div. . . . .	58		
Carter Motor Co. . . . .	60	<b>R</b>	
Centralab Div. Globe Union, Inc. . . . .	6	Raytheon Mfg. Co. . . . .	64
Cinch Manufacturing Corp. . . . .	43	R-B-M Mfg. Co. . . . .	59
Clare & Co., C. P. . . . .	77	RCA Manufacturing Co. . . . .	Fourth Cover
Collins Radio Co. . . . .	49	Rex Rheostat Co. . . . .	87
Continental Electric Co. . . . .	86	Rider Publisher, Inc., John F. . . . .	68
Cornell-Dubilier Electric Corp. . . . .	11		
Cross, H. . . . .	87		
<b>D</b>		<b>S</b>	
Daven Co. . . . .	69	Shure Brothers . . . . .	56
Davenoil Co. . . . .	79	Signal Indicator Corp. . . . .	87
Doyle, Inc., James W. . . . .	87	Sola Electric Co. . . . .	71
Drake Mfg. Co. . . . .	89	Solar Mfg. Co. . . . .	87
Driver Co., Wilbur B. . . . .	77	Stackpole Carbon Co. . . . .	67
DuMont Laboratories Inc., Allen B. . . . .	74	Standard Pressed Steel Co. . . . .	68
		Sun Radio Co. . . . .	87
<b>E</b>		<b>T</b>	
Eicor . . . . .	66	Taylor Fibre Co. . . . .	80
Eisler Engineering Co. . . . .	87	Terminal Radio Corp. . . . .	87
Eitel-McCullough, Inc. . . . .	51	Thomas & Skinner Steel Pds. Co. . . . .	83
Eric Resistor Corp. . . . .	4	Triplett Electrical Instrument Co. . . . .	64
		Turner Co. . . . .	79
<b>G</b>		<b>U</b>	
General Electric Co. . . . .	7, 63	Union Carbide & Carbon Corp. . . . .	53
G-M Laboratories, Inc. . . . .	71	United Transformer Corp. . . . .	Second Cover
Guardian Electric Mfg. Co. . . . .	83		
<b>H</b>		<b>W</b>	
Hallcrafters, Inc. . . . .	70	Western Electric Co. . . . .	8, 58
Harvey Radio Co. . . . .	87	Westinghouse Electric & Mfg. Co. . . . .	44, 45
Hewlett-Packard Co. . . . .	52	Weston Electrical Instrument Corp. . . . .	57
Heintz & Kaufman, Ltd. . . . .	5	White Dental Mfg. Co., S. S. . . . .	75
Hipower Crystal Co. . . . .	87	Wilson Co., H. A. . . . .	80
Hunter Pressed Steel Co. . . . .	79		
<b>I</b>		<b>Professional Services . . . . .</b>	<b>85</b>
Instrument Resistors, Inc. . . . .	83		
International Resistance Co. . . . .	55		
Irrington Varnish & Insulator Co. . . . .	54		
Isolantite, Inc. . . . .	47		
<b>J</b>		<b>SEARCHLIGHT SECTION</b>	
Jackson Electrical Instrument Co. . . . .	70	(Classified Advertising)	
Jones, Howard B. . . . .	86	EMPLOYMENT . . . . .	88
		USED EQUIPMENT FOR SALE	
<b>K</b>		Callite Tungsten Corp. . . . .	88
Kenyon Transformer Co. . . . .	78	Kahle Engineering Corp. . . . .	88
Keuffel & Esser Co. . . . .	3		



**Why**  
VARNISHED

# TURBO

**TUBING AND SATURATED SLEEVING**

*This is why—*

LOW MOISTURE ABSORPTION—GREATER  
SAFETY FACTOR—LONGER LIFE...

THOROUGH IMPREGNATION—  
SOLID VS VENEER PROCESS—NO CRACKING

SPECIAL FORMULA OF NATURAL OILS—  
LINSEED OIL BASE—INCREASED DIELECTRIC  
VALUES—ARCING SUPPRESSED...

FLEXIBILITY TO MEET ALL ELECTRICAL  
AND MECHANICAL REQUIREMENTS

INSIDE IMPREGNATION FOR RAPID  
SNAKING AND FISHING—EXTREMELY  
ELECTRO CHEMICAL & HYDROSTATIC RESISTANT

AN AMERICAN PRODUCT MADE IN AMERICA  
TURBO IS THE ULTIMO IN SLEEVE INSULATION

● Write for SAMPLE BOARD

**WILLIAM BRAND & COMPANY**

Block Mica, Mica Plate and products—Varnished oil tubing, Saturated Sleevings, Varnished Cambric, Cloths and Composites

276 FOURTH AVE., NEW YORK, N. Y.

217 NO. DESPLAINES ST., CHICAGO, ILL.



**SO SENSITIVE IT CAN BE USED TO MEASURE THE LIGHT OF STARS!**

**Sensitivity,  
2,300,000  
Microamperes  
Per Lumen\***



**RCA-931 MULTIPLIER  
PHOTOTUBE  
List Price \$12.00**

In its ability to provide in a single tube a sensitivity of almost 2½ million microamperes per lumen, the new RCA-931 Multiplier Phototube heralds engineering developments almost staggering to the imagination. Unquestionably one of the most outstanding developments in phototube history, it holds truly amazing possibilities in a wide variety of applications ranging from use with light-operated relays, sound production in films and facsimile transmission, to astronomical observations and scientific research involving extremely low levels of light.

The RCA-931 is a high-vacuum tube capable of multiplying the feeble currents produced by weak illumination on its photo cathode as much as 230,000 times!

It has a low noise level, low dark-current characteristic, and is remarkably free from distortion. The tube can be coupled to any practical load impedance.

The S-4 photosurface employed is unusually sensitive to blue-rich light. Its sensitivity to incandescent light at a temperature of approximately 2600° K is comparable to that obtained with the well-known S-1 photosurface, but increases rapidly for light sources at higher temperatures.

The RCA-931 is available through RCA Tube and Equipment distributors. Technical bulletin on request to RCA Commercial Engineering Section, Harrison, N. J.

\*For RCA-931 at maximum voltage, and average value, for incandescent light source at 2870° K.

**RCA's Newest and Finest Transmitting Tube Guide**

Don't miss the new "RCA Guide for Transmitting Tubes"! 50% bigger than last year. Includes details on all RCA Air-Cooled Transmitting Tubes plus typical circuits and much important new construction data. Net price 25¢, from your RCA Tube and Equipment Distributor or RCA Commercial Engineering Section, Harrison, N. J.

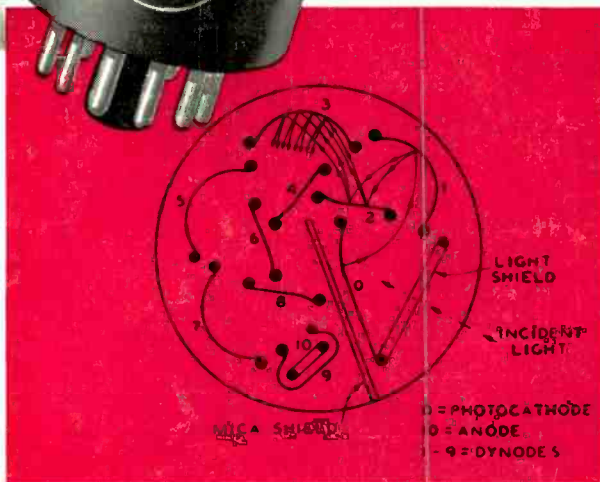
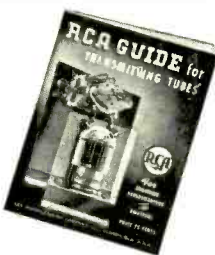

**9-Stage Electrically-Focused Construction**

As illustrated in this cross-section drawing, the RCA-931 contains nine dynodes, or secondary emitters. Electrons from the photo cathode are directed by fixed electrostatic fields along curved paths to the first dynode where they produce many other electrons at the moment of impact.

These secondary electrons are then directed to the second dynode and, in turn, free new electrons.

This multiplying process is repeated successively in each stage with an ever-increasing electron stream. Electrons emitted from the ninth dynode are collected by the anode and constitute the current utilized in the output circuit—a useful multiplication of the initial photo-cathode current of about 230,000 times!



**Phototubes**

**UNIFORMITY • DEPENDABILITY • SENSITIVITY**

RCA MANUFACTURING CO., Inc. Camden, N. J. • A Service of the Radio Corporation of America

For Canadian prices write to RCA Victor Company Limited, Montreal

